



Kurdistan Regional Government
Council of Ministers
Ministry of Education

Sunrise

2

Activity Book

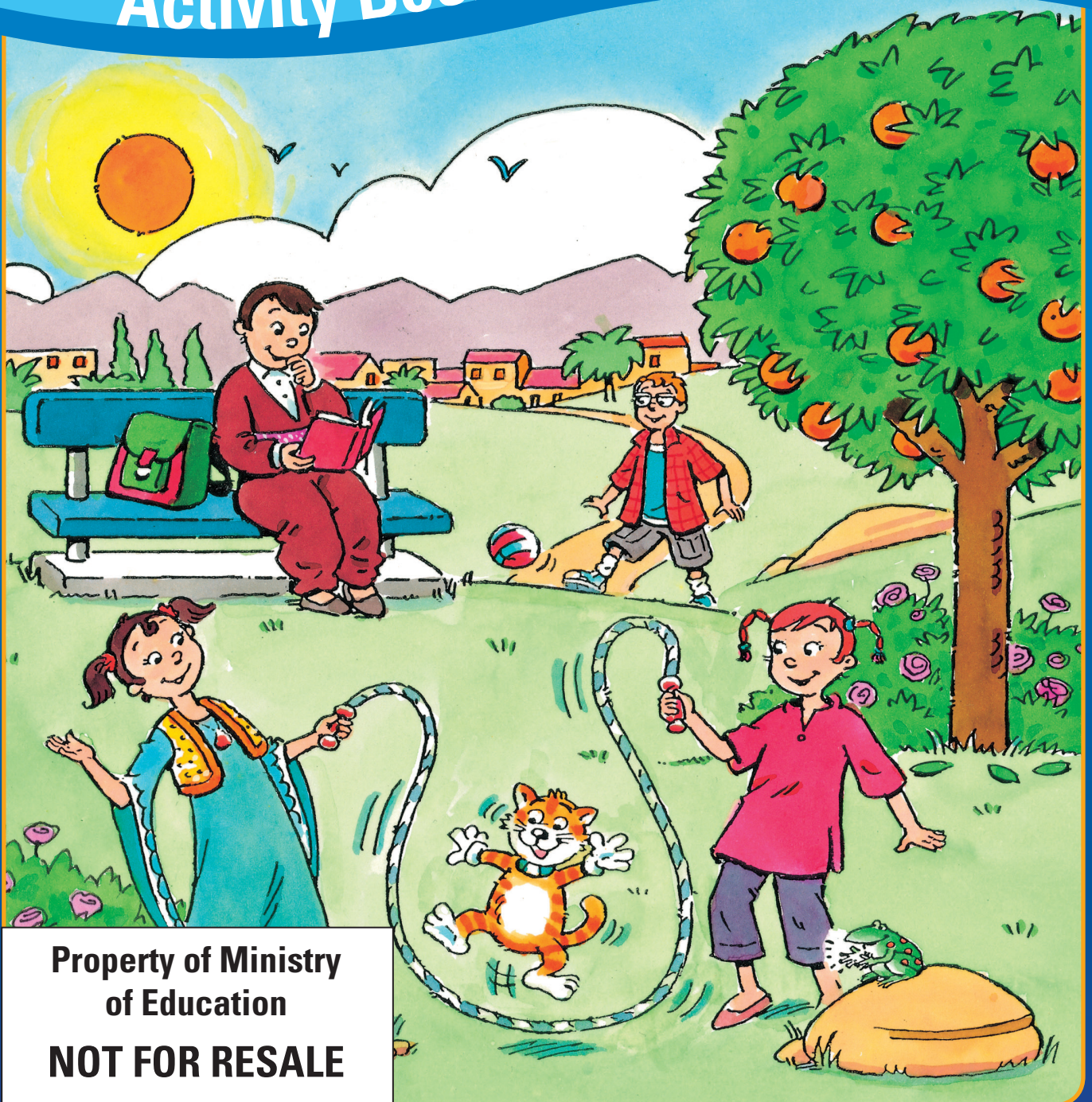

Property of Ministry
of Education
NOT FOR RESALE

Sunrise

Activity Book

2



Kurdistan Regional Government
Council of Ministers
Ministry of Education

حکومتی هه‌ریمی کوردستان - عێراق
وهزاره‌تی په‌روه‌رده - به‌ریوه‌به‌رایه‌تی گشتی پرۆگرام وچا په‌مه‌نبیه‌کان

نهم په‌رتووکه مولکی وهزاره‌تی (په‌روه‌رده)ی حکومتی هه‌ریمی کوردستانه ، فرۆشتنی له بازار
قه‌ده‌غیه‌و دژ به یاسایه .

Hilary Thompson

Unit 1 Lesson 1

Listen and tick



1



2



3



4



5

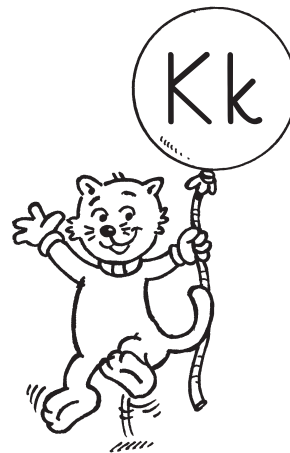

Unit 1 Lesson 2

Trace and write



aaa bbb ccc ddd eee fff



ggg hhh iii jjj kkk

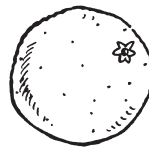

lll mmm nnn ooo ppp

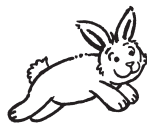

qqq rrr sss ttt uuu

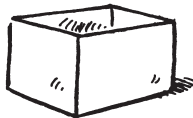
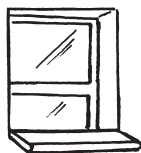

vvv www xxx yyy zzz

Unit 1 Lesson 3

Join and say

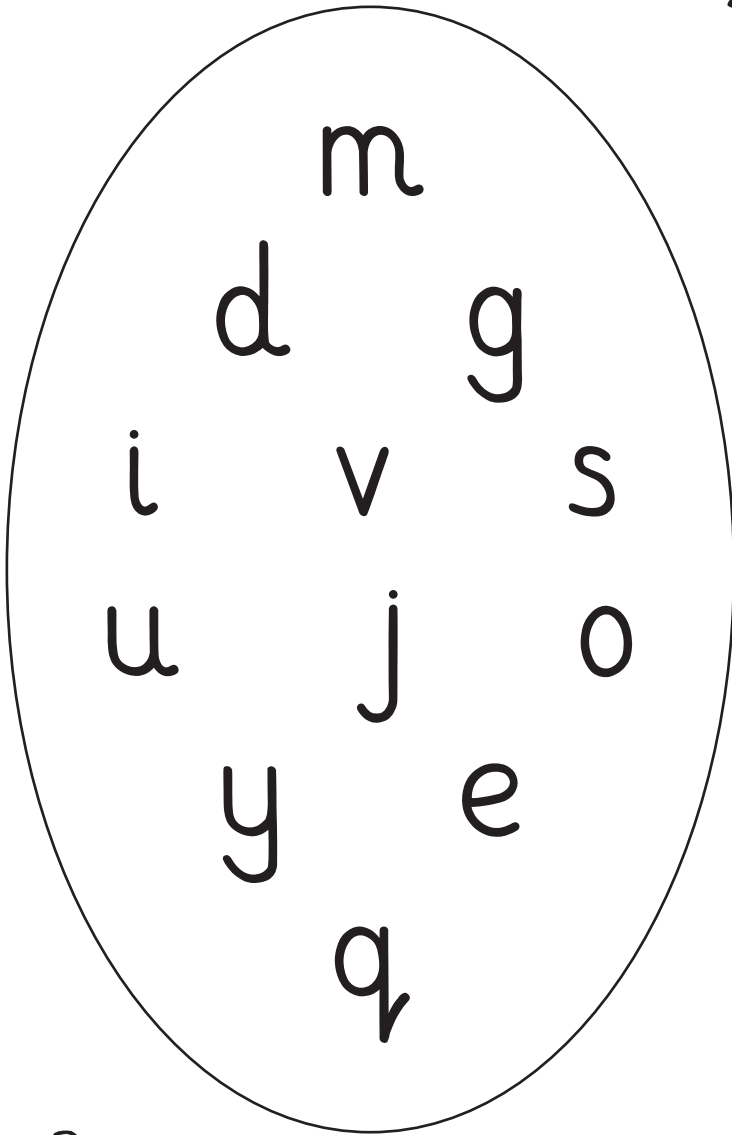
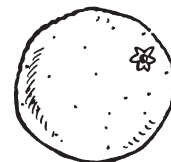
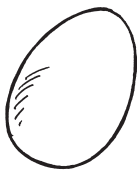

Unit 2 Lesson 1

Trace and write

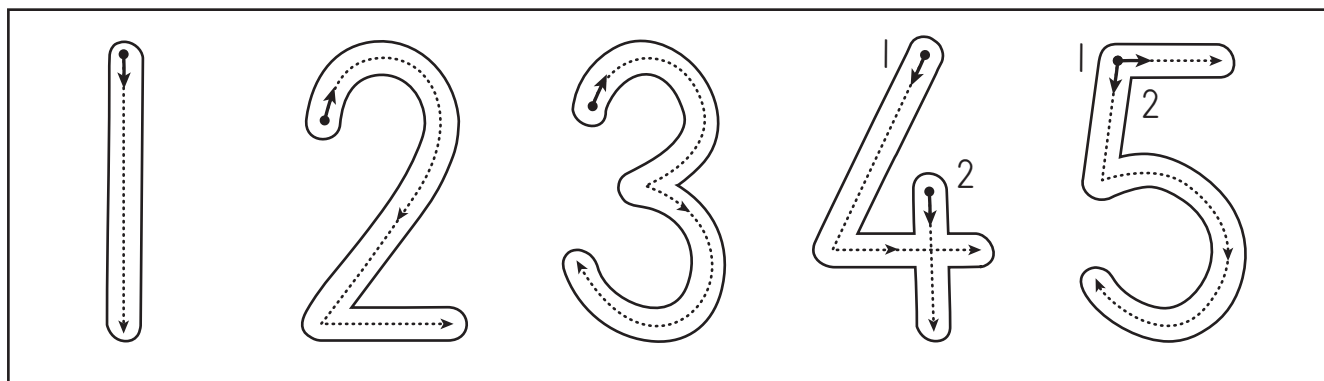

1				
2	2	2	2	
3	3	3	3	
4	4	4	4	
5	5	5	5	

Listen and write



				
<input type="text"/>	<input type="text"/>	<input type="text"/>	<input type="text"/>	<input type="text"/>

Unit 2 Lesson 2

Listen and circle



1



2



3



4

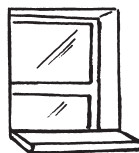

Listen, say and draw



1

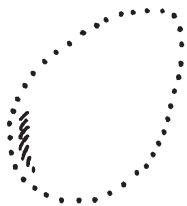

2

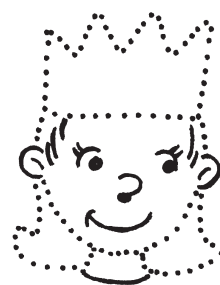

3



4

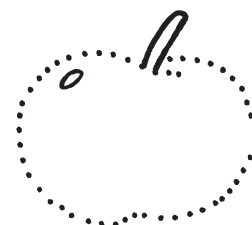

Unit 2 Lesson 3

Join and draw

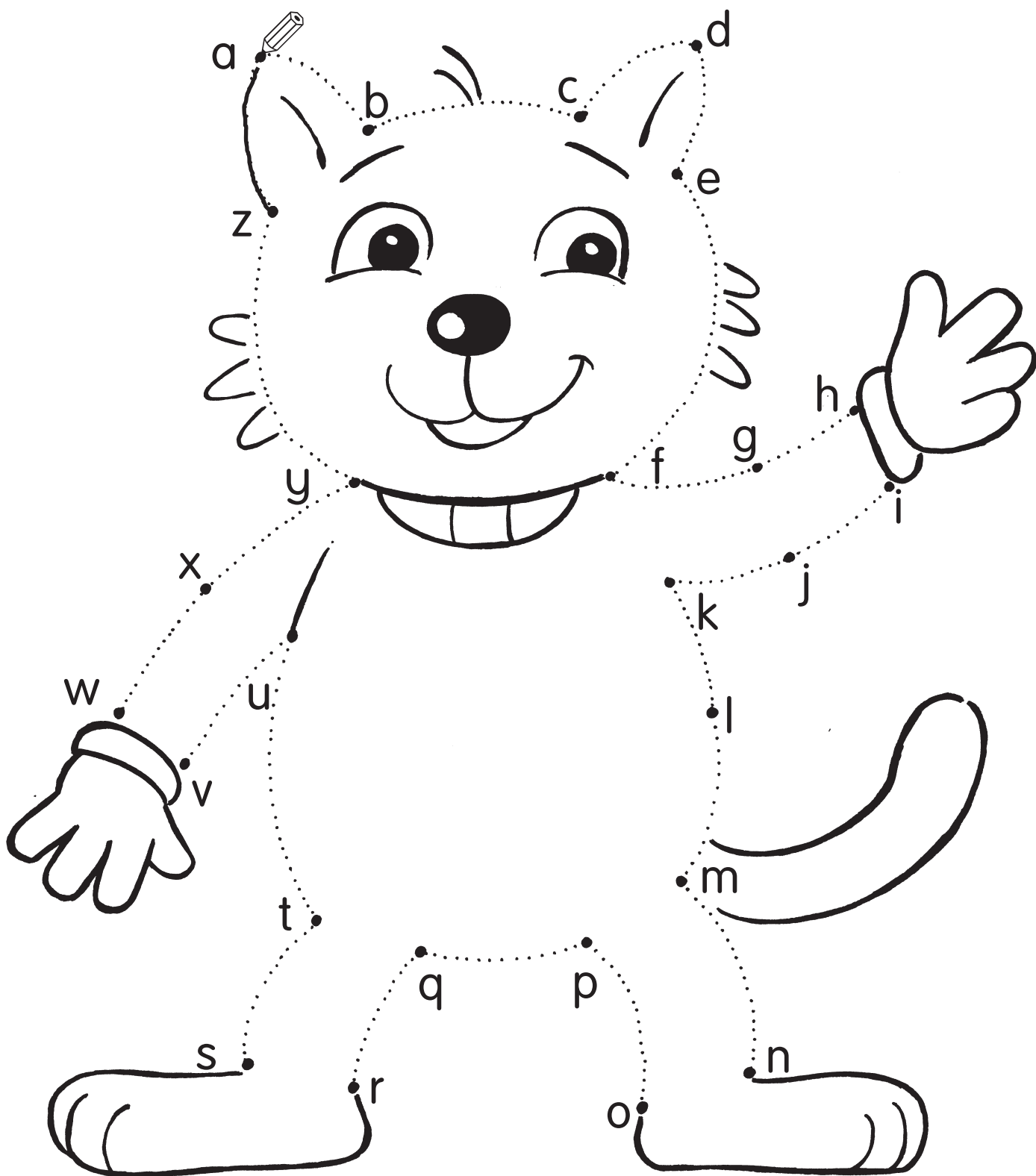

Unit 3 Lesson 1

Count and write 23 



Listen and circle  

1

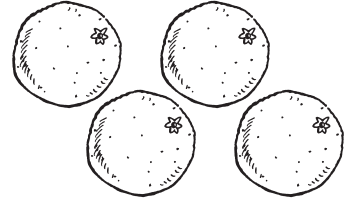
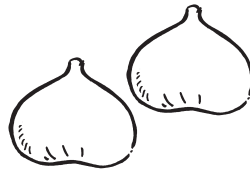
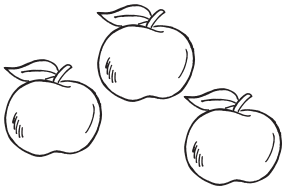

2



3



4

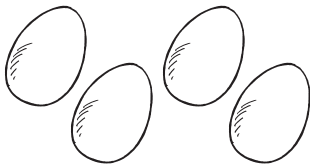

5

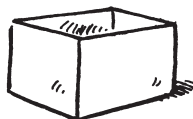

Unit 3 Lesson 2

Trace and write

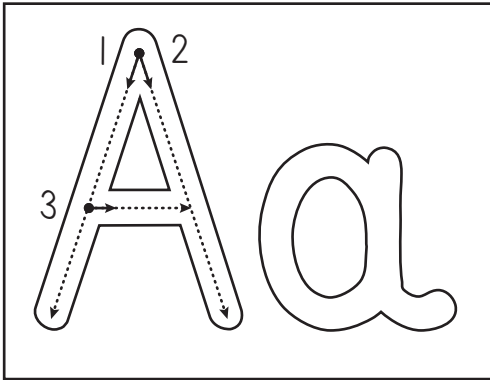

A A A

Aa Aa



ant _nt _nt



apple _pple _pple



Aveen _veen _veen

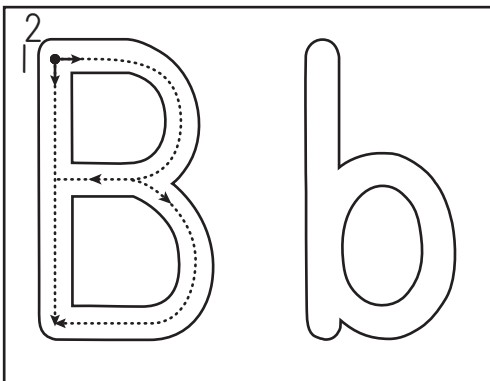

B B B

Bb Bb



banana _anana _anana



bag _ag _ag

Unit 3 Lesson 3

Trace and write

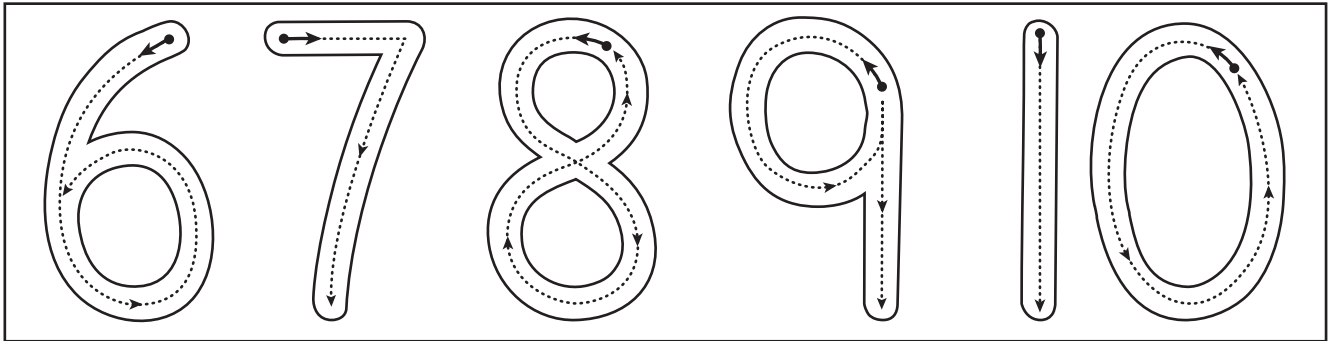

6 6 6 6

7 7 7 7

8 8 8 8

9 9 9 9

10 10 10

Count, match and circle

1 2 3

7

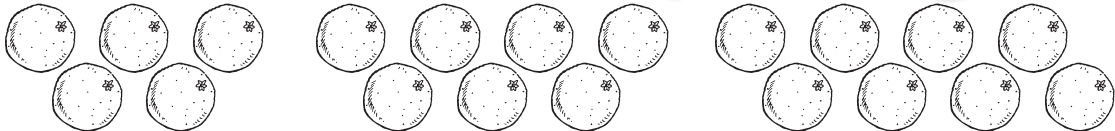

10

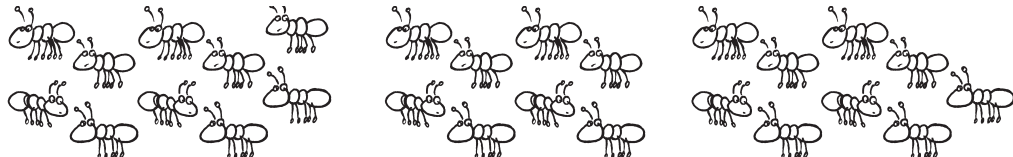

8

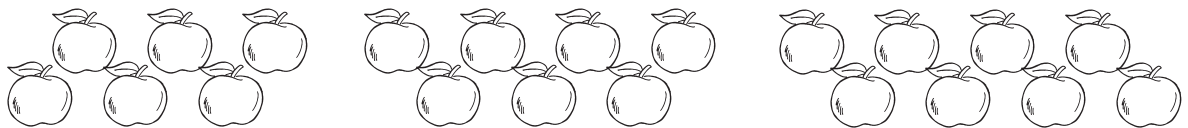

10

Revision 1

Count and write 123 



Revision I

Listen and circle



1



2



3

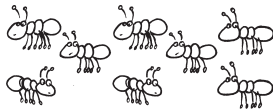

4



5



6



7



8



Listen, match and write

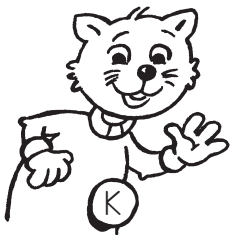

Unit 4 Lesson 1

Listen and match



1

2

3

4

5

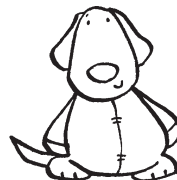

Match and circle



a



b



c



d



Unit 4 Lesson 2

Trace and write

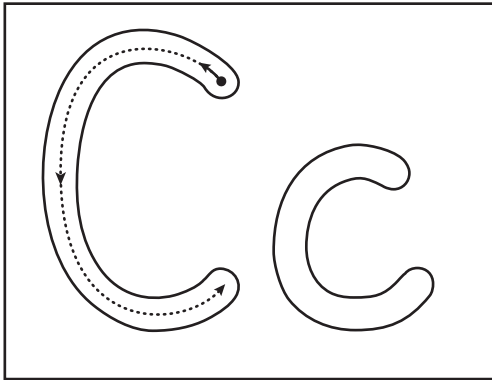

C C C
C c C c



car _ar _ar



cap _ap _ap



cat _at _at

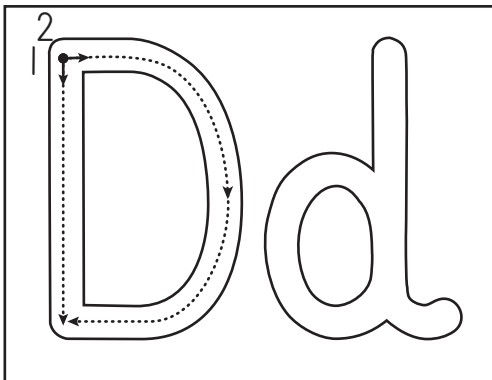

D D D
D d D d



doll _oll _oll



dog _og _og



duck _uck _uck

Unit 4 Lesson 3

Listen and tick



Unit 5 Lesson 1

Listen and write

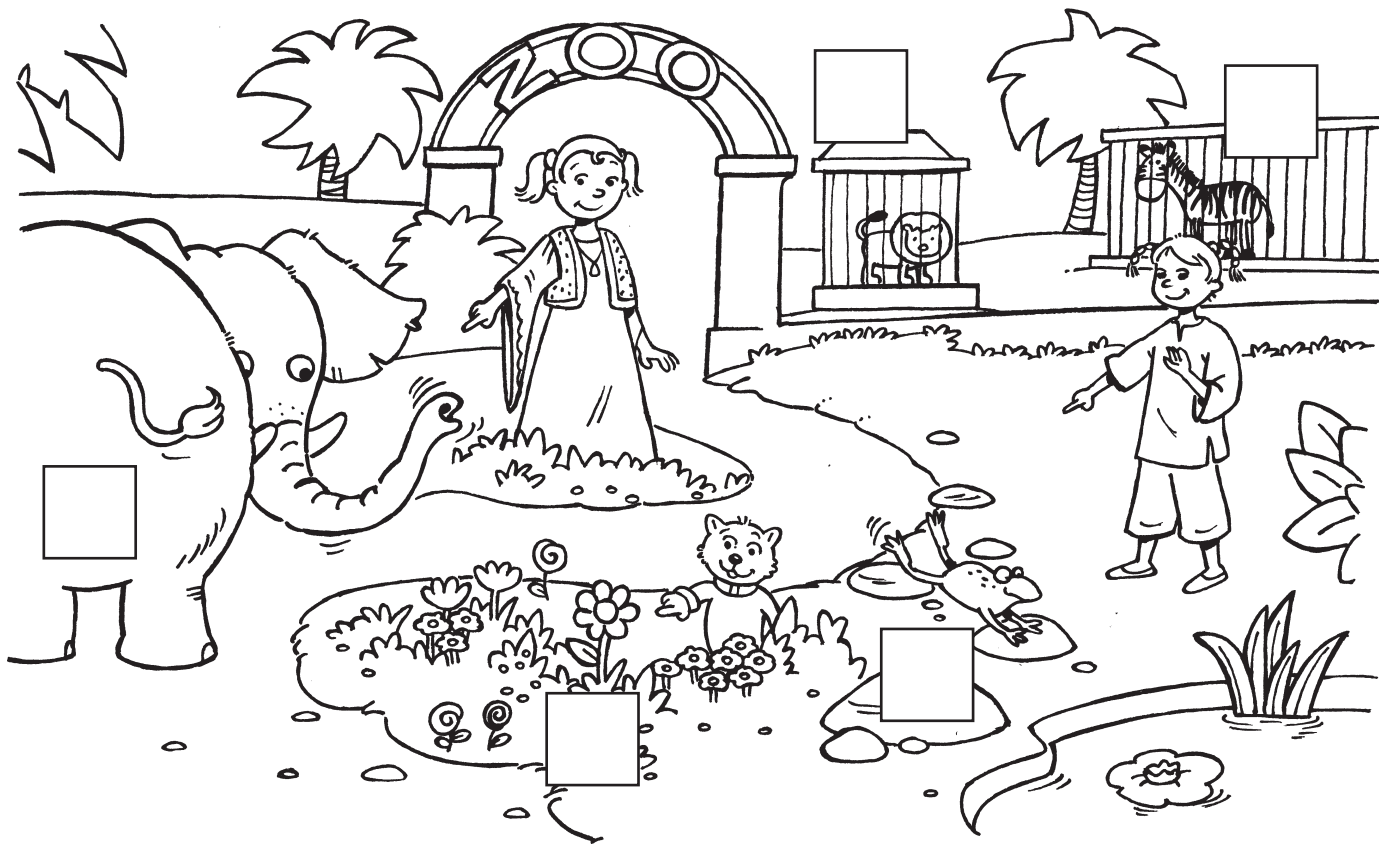

Trace, listen and colour

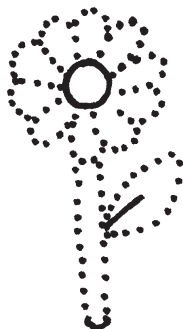
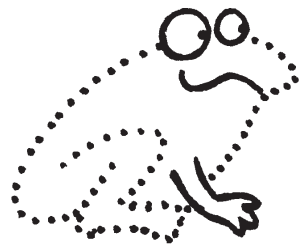
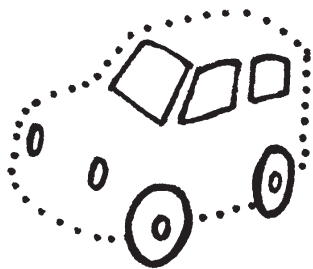

Unit 5 Lesson 2

Trace and write

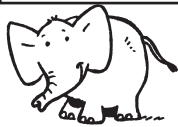
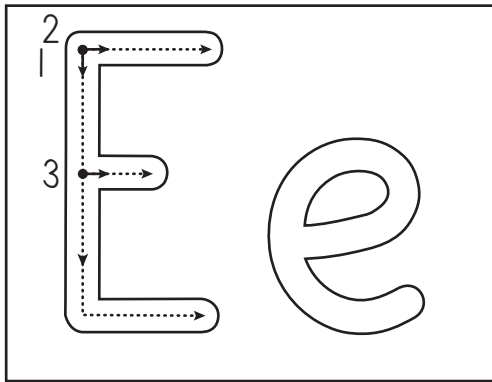

elephant

_lephant

_lephant



egg

_gg

_gg

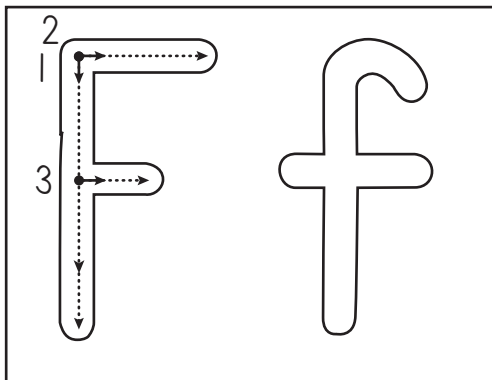

flower

_lower



frog

_rog

_rog



fig

_ig

_ig

Match and join



a



f



d



A



e

Unit 5 Lesson 3

Count and write 23 

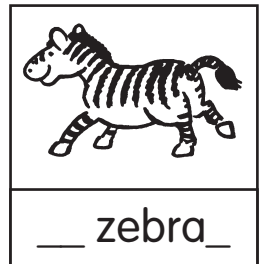
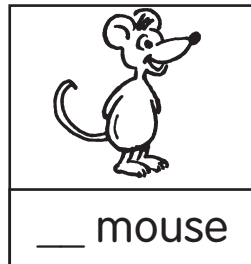
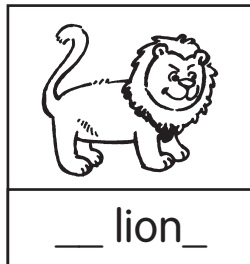
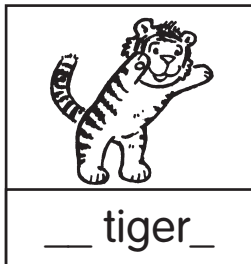
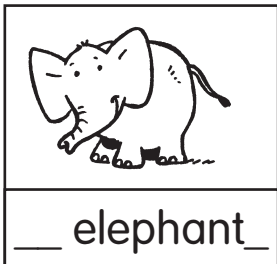
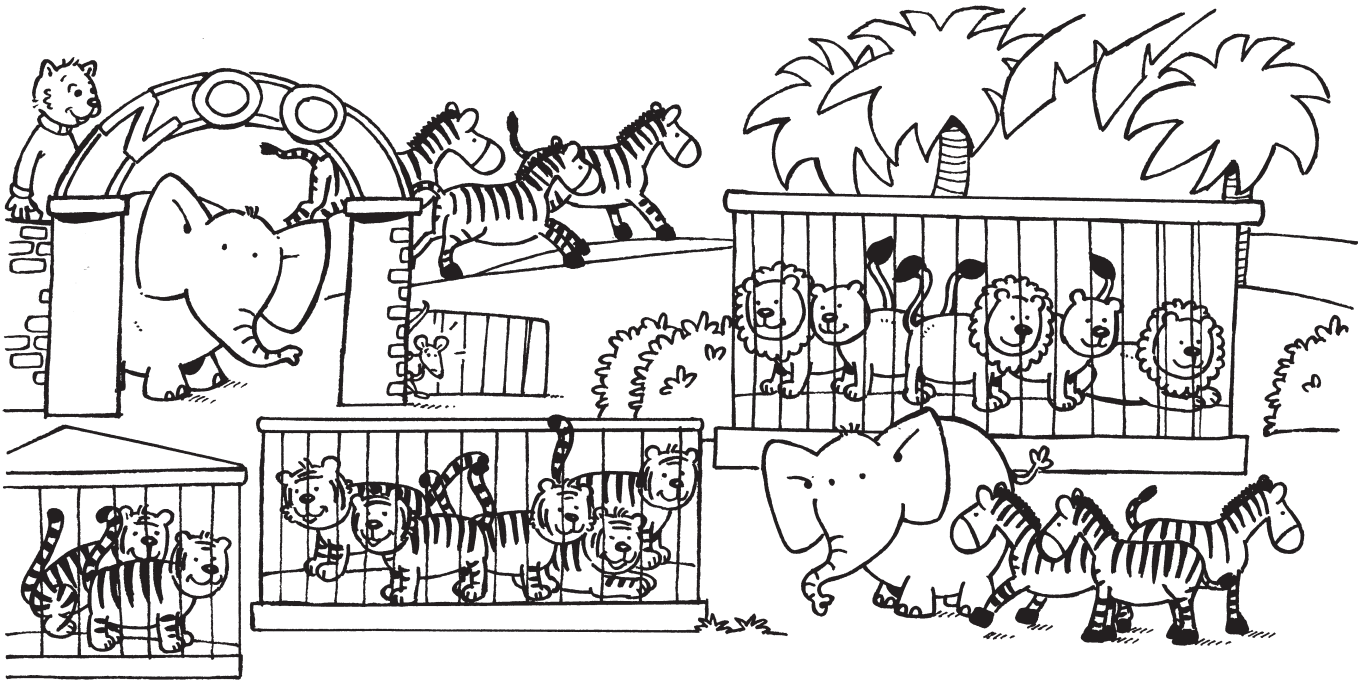

Find and write  



_ion

_iger

_ebra

_ouse

_at

_og

z m t d l c

Unit 6 Lesson 1

Listen and join

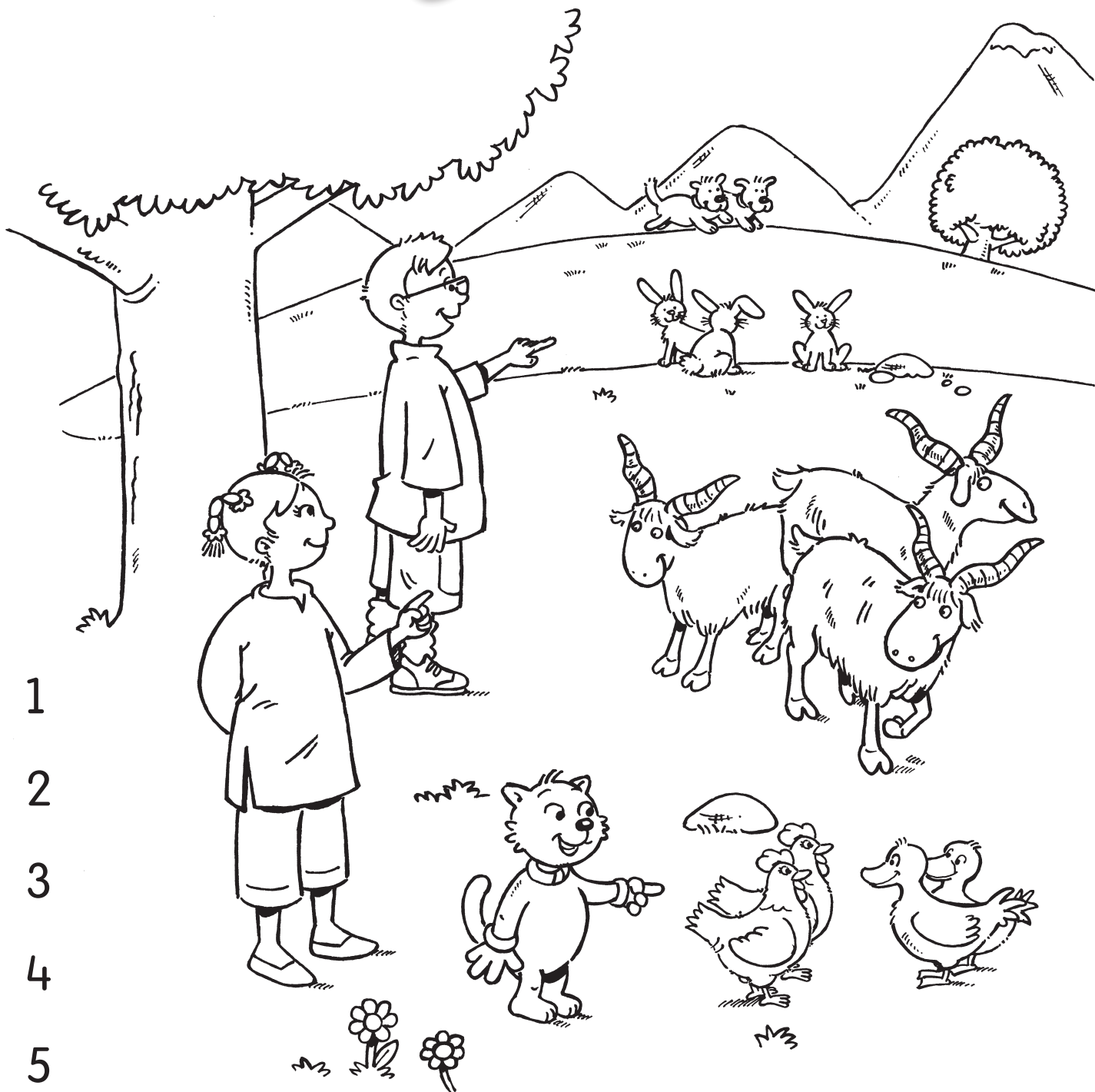

Ask and answer



Unit 6 Lesson 2

Trace and write

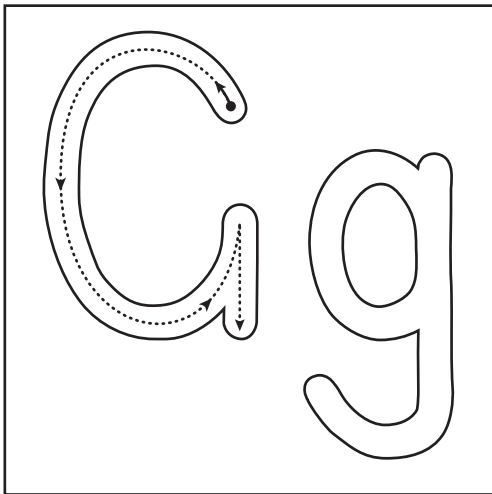

C C C
Gg Gg



goat _oat _oat



gate _ate _ate

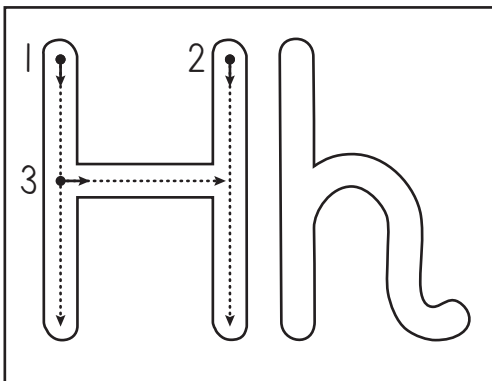

H H H
Hh Hh



hat _at



hen _en

Match



H

C

D

A

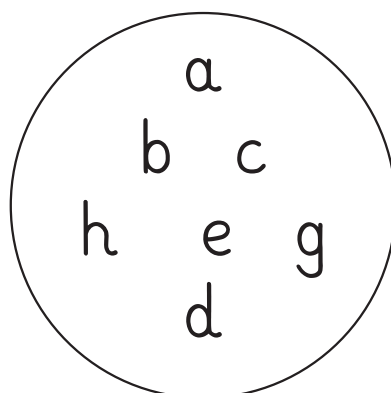

G

E

B

Unit 6 Lesson 3

Listen and circle

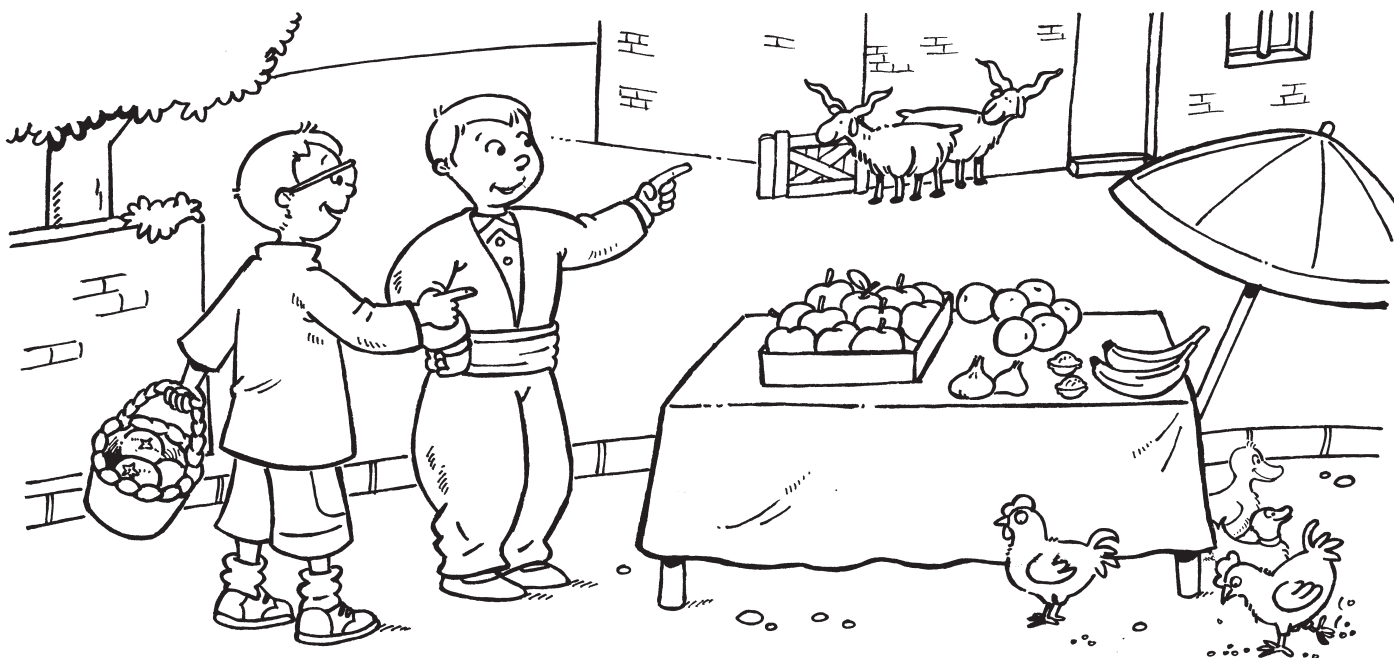

Join and trace

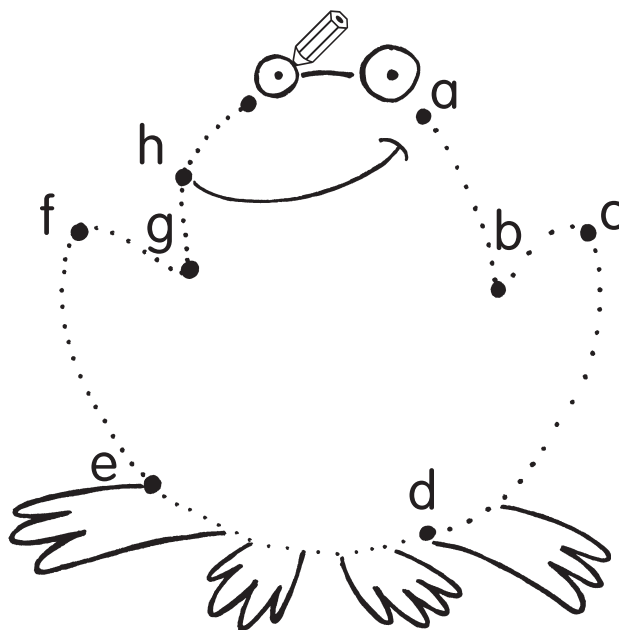
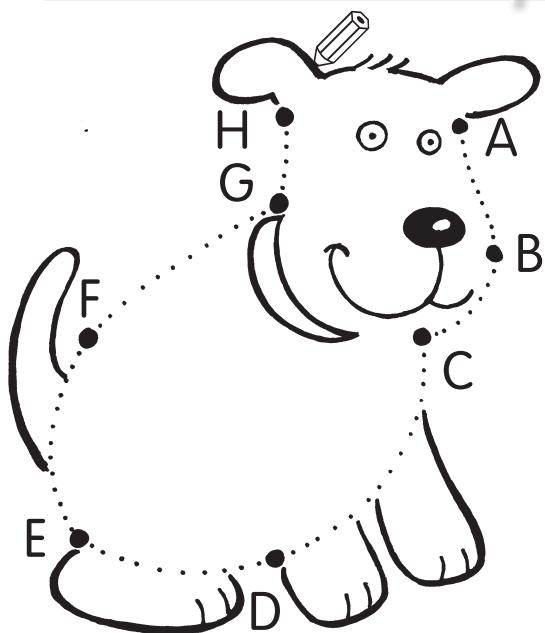

Revision 2

Listen and write

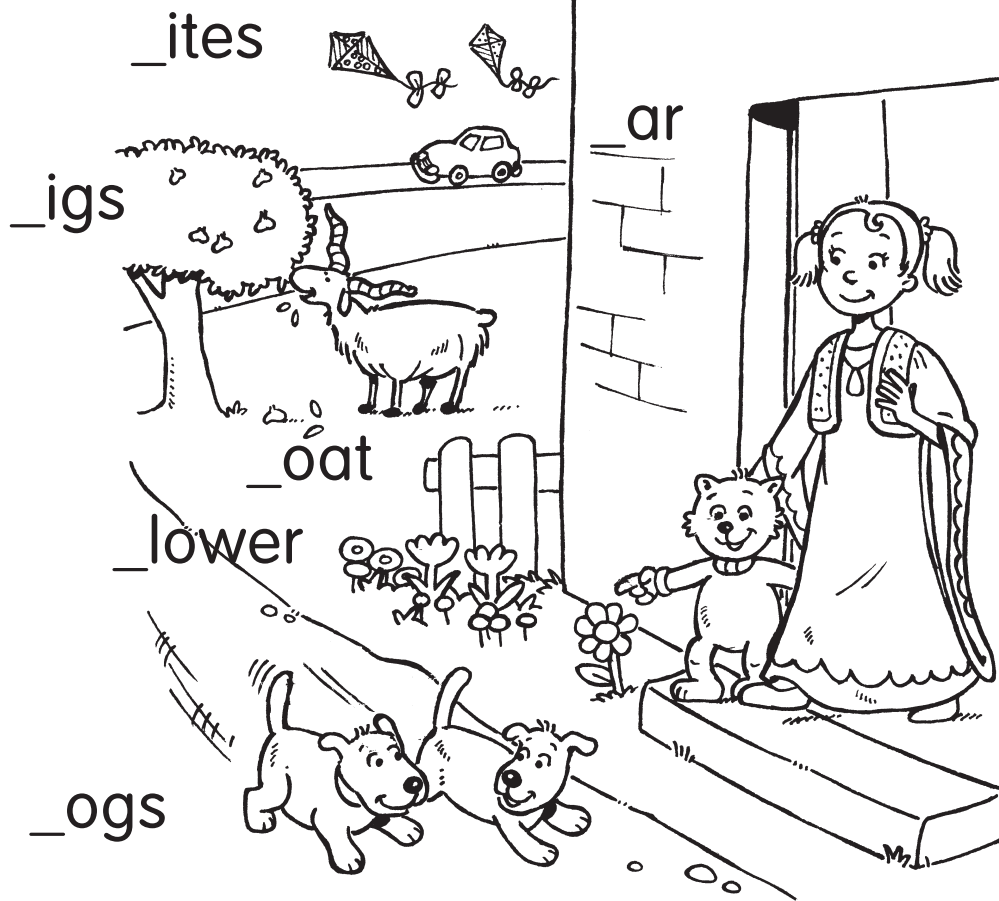

Listen and colour

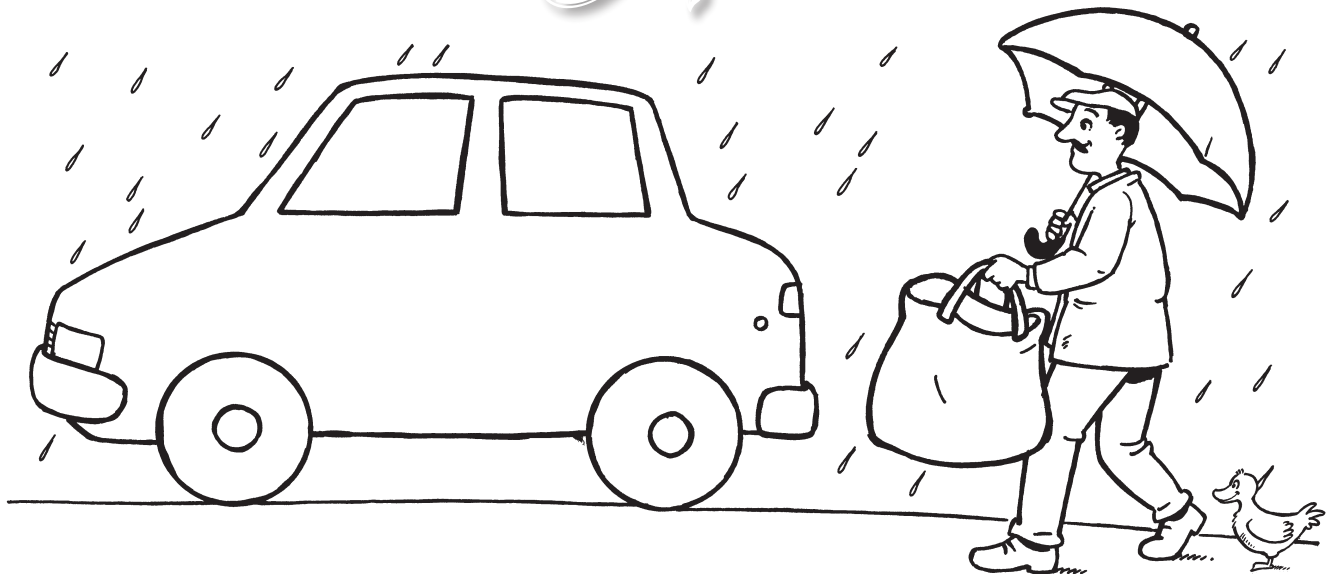

Revision 2

Find and write

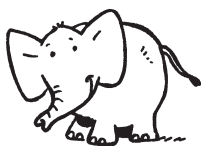

a

b

c

d

e

f

g

h

Unit 7 Lesson 1

Listen and match

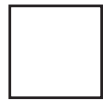
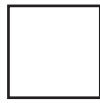
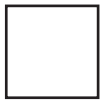
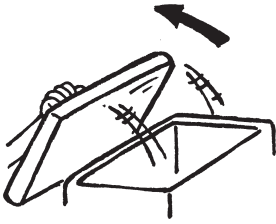

Join



h

g

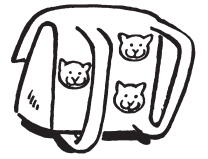

bag

a

b

t



hat

t



cap

c

a

p



cat

Unit 7 Lesson 2

Trace and write

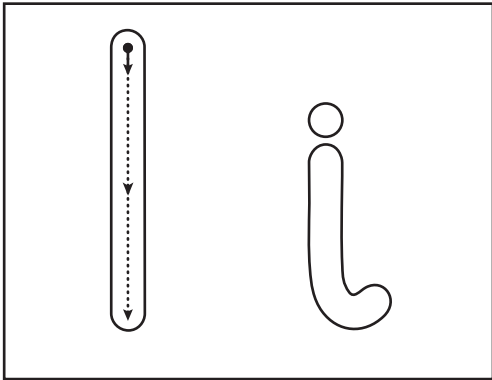

insect _nsect _nsect



ice cream _ce cream _ce cream

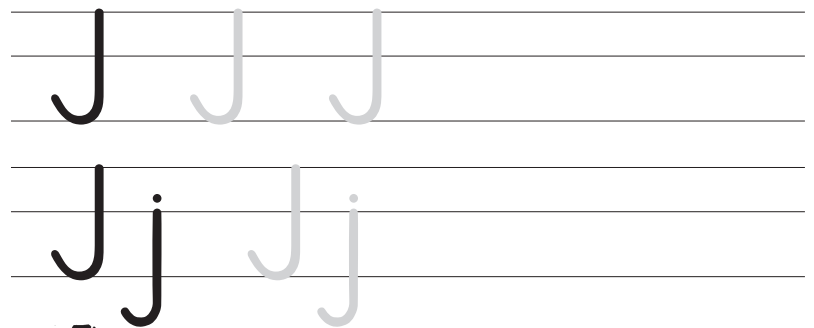
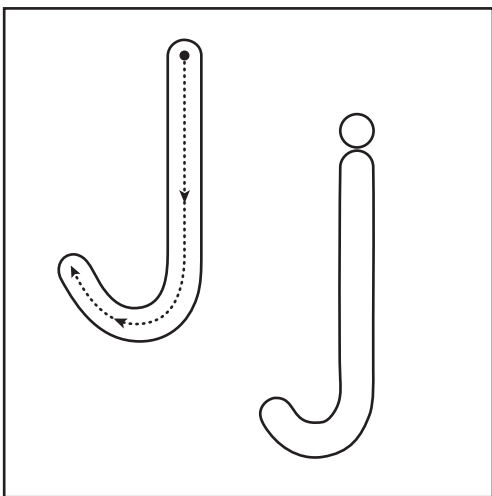

juice _uice _uice



jam _am _am



jug _ug _ug

Unit 7 Lesson 3

Match and join

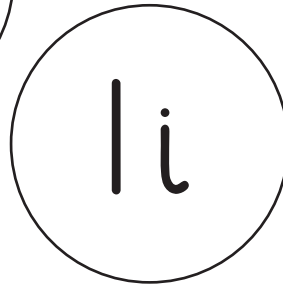
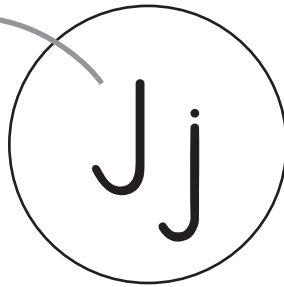

Trace and write



cat cat cat cat



hat hat hat hat



jam jam jam jam



bag bag bag bag











cap cap cap cap

Unit 8 Lesson 1

Listen and tick



1		<input type="checkbox"/>		<input type="checkbox"/>
2		<input type="checkbox"/>		<input type="checkbox"/>
3		<input type="checkbox"/>		<input type="checkbox"/>
4		<input type="checkbox"/>		<input type="checkbox"/>

Count and circle 1 2 3 0

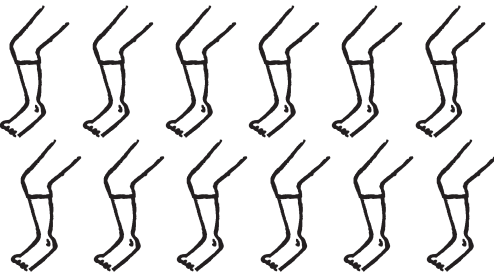
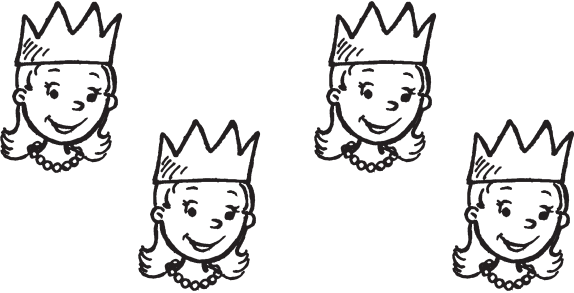
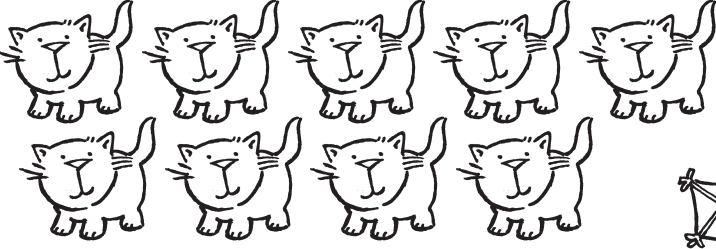
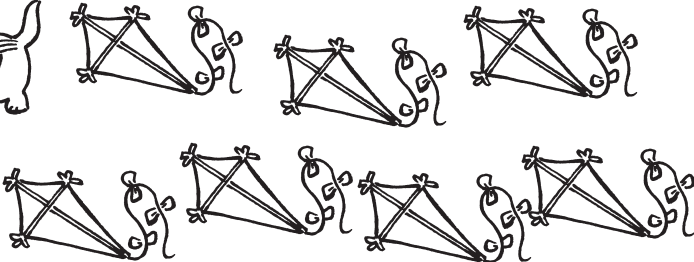
	
11 12 13	6 5 4
	
9 10 11	8 7 6

Unit 8 Lesson 2

Trace and write

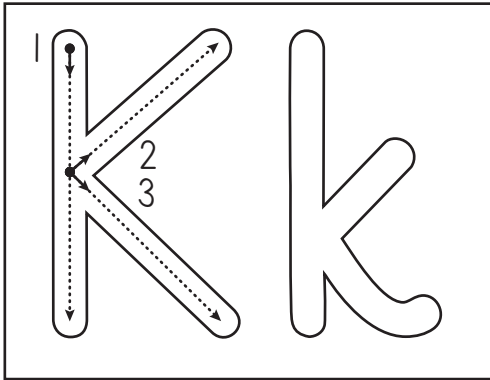

king

_ing

_ing



kitten

_itten

_itten

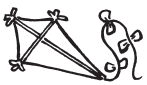

kite

_ite

_ite



Kitty

_itty

_itty



Karwan

_arwan



Kurdistan

_urdistan

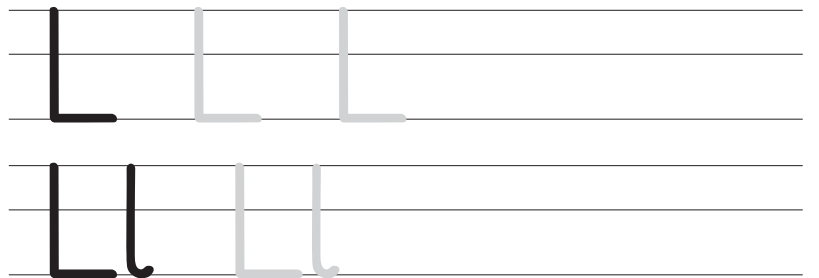
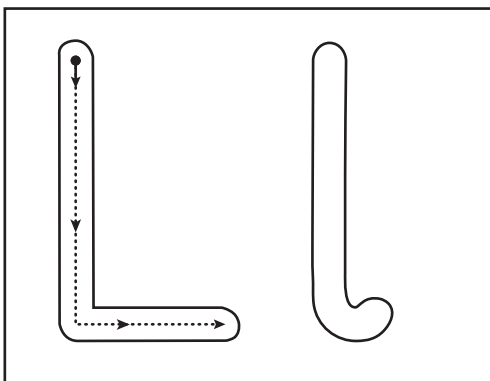

leg

_eg

_eg



lion

_ion

_ion



Laura

_aura

_aura

Unit 8 Lesson 3

Trace and write



1 1 1 1 1 1

2 2 2 2 2

3 3 3 3 3

4 4 4 4 4

5 5 5 5 5

6 6 6 6 6

Listen, join and write



13 caps _____ 11







bags _____ hats _____ 14

cars _____ cats _____ 15

Unit 9 Lesson 1

Listen and circle



1  yes no	2  yes no
3  yes no	4  yes no
5  yes no	6  yes no

Trace and write



yes yes yes yes yes
no no no no no

Unit 9 Lesson 2

Trace and write

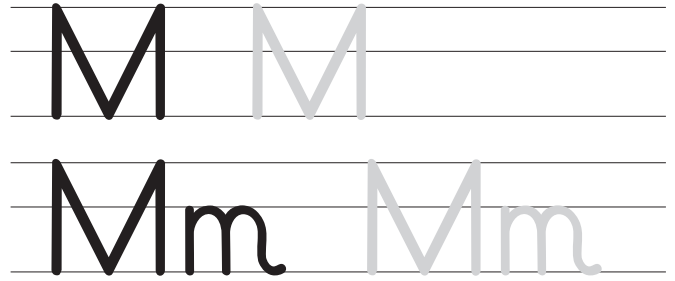
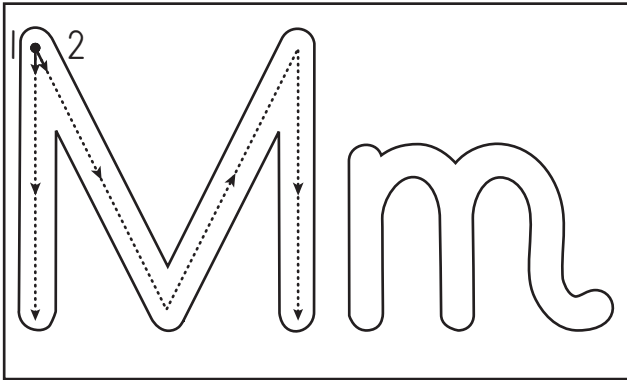

monkey _onkey _onkey



mouse _ouse _ouse

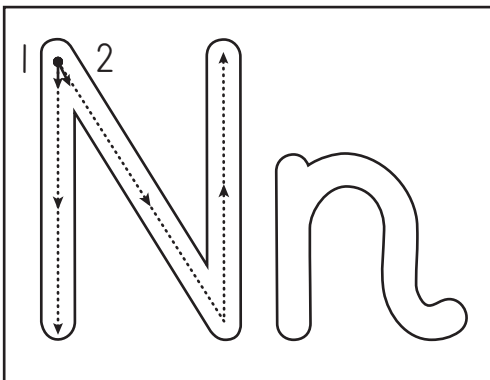

nose _ose _ose



nut _ut _ut



neck _eck

Trace and write



leg leg leg leg



ten ten ten

Unit 9 Lesson 3

Trace and match



pen

ten

leg

hen



10

Match and write



1



2

10

pen leg hen ten

ten hen leg pen

3



4



ten leg pen hen

leg hen pen ten

Revision 3

Find, match and trace



leg

ten

jam

pen

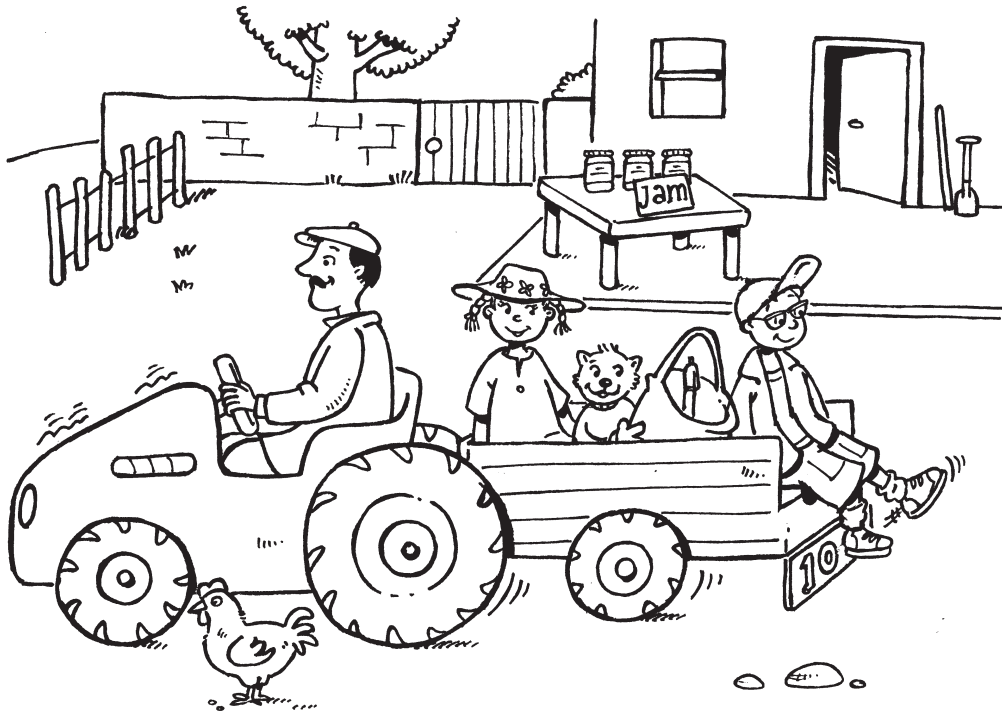

cap

hen

bag

hat

Listen and match



Revision 3

Circle and write



1



bag jam hat

2

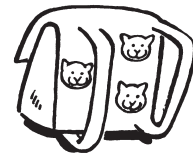

cap bag hat

3



jam bag cat

4



hat cat cap

Listen and circle



1

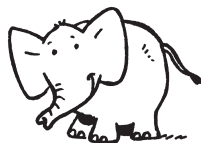

yes no

2



yes no

3



yes no

4



yes no

Unit 10 Lesson 1

Trace and write



17 17 17 17 17

18 18 18 18 18

19 19 19 19 19

20 20 20 20 20

Listen and join

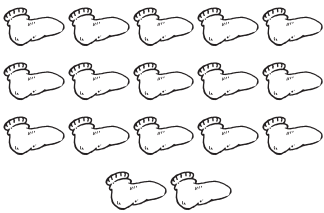
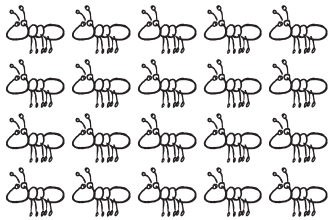
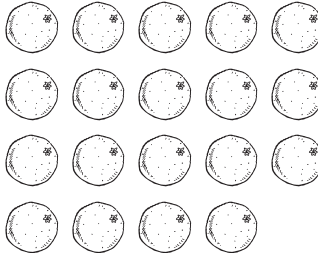
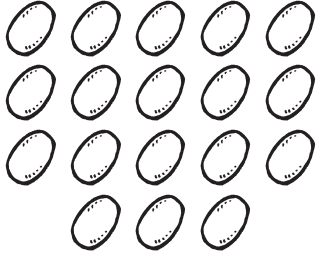

			
20	18	17	19

Count, say and write

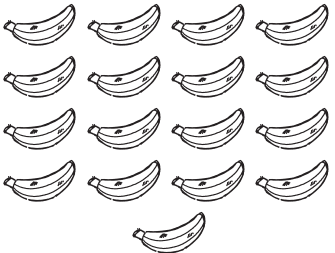
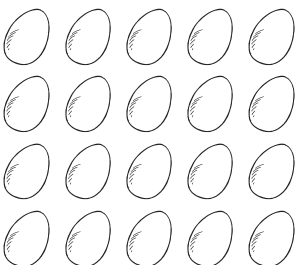
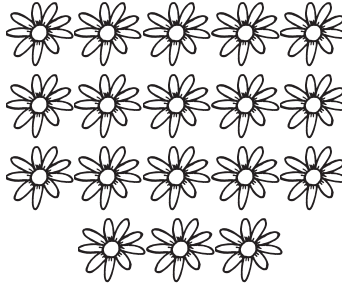
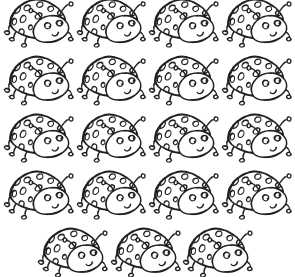

			
<input type="text"/>	<input type="text"/>	<input type="text"/>	<input type="text"/>

Unit 10 Lesson 2

Trace and write

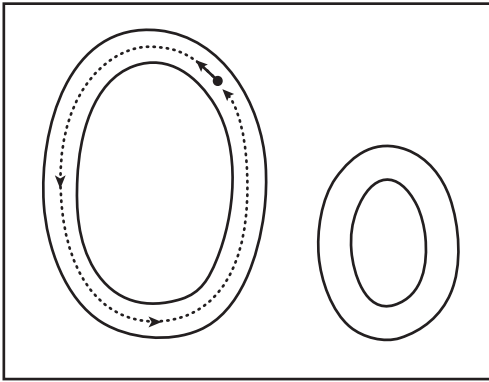

O O O
Oo Oo



olive _live _live



orange _range _range

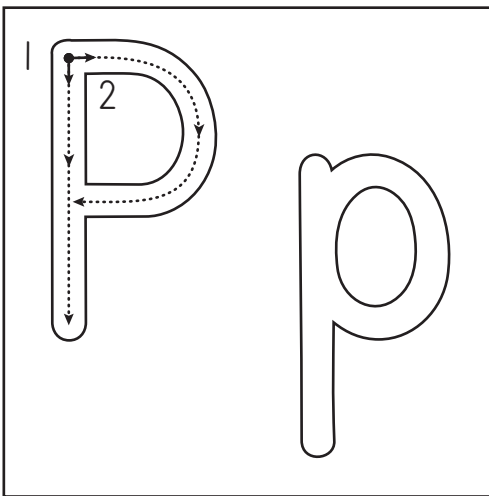

P P P
Pp Pp



parrot _arrot _arrot



pot _ot _ot



pen _en _en

Unit 10 Lesson 3

Join and draw

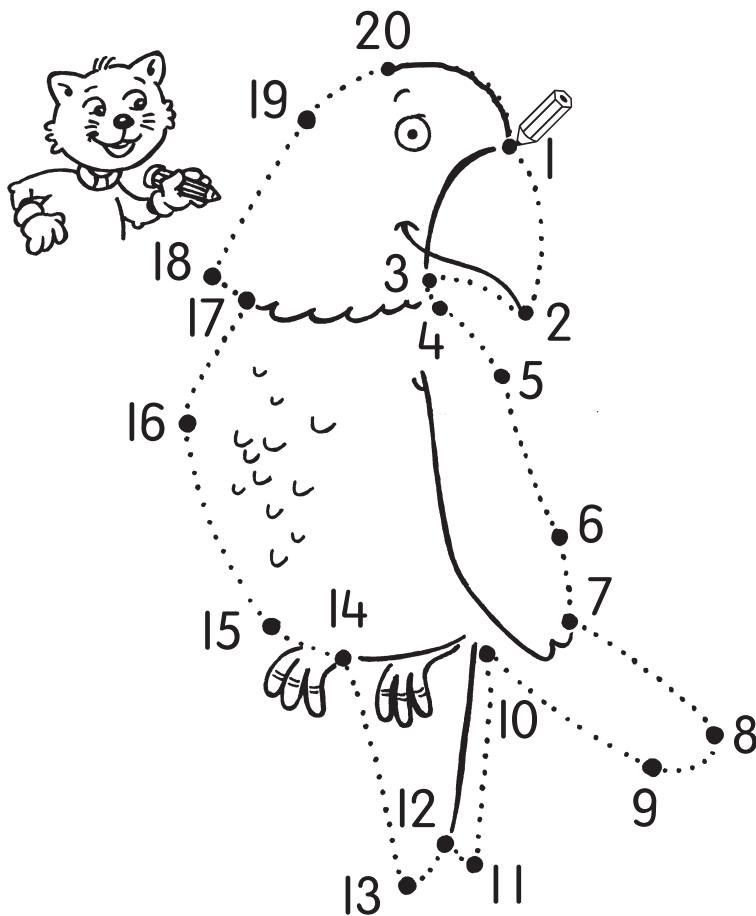

Listen and write



1 ___ cats _____

2 ___ pens _____

3 ___ bags _____

4 ___ legs _____

Unit II Lesson I

Listen and write













Join



A large circle containing a word search puzzle. The letters are arranged as follows:

	P	B	I	
				M
G		o		
	b		i	D
O	p	a	n	
	j	m	e	K
H	f	g	l	
	h		c	A
C	d	k		L
	J		F	
	E	N		

A line starts at the letter 'a' and ends at the letter 'l'.

Unit 11 Lesson 2

Trace and write

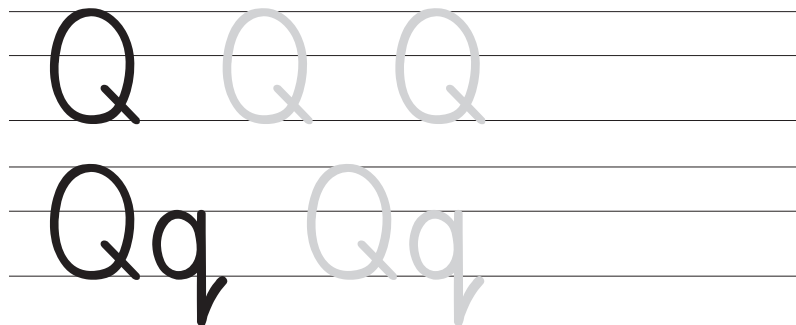
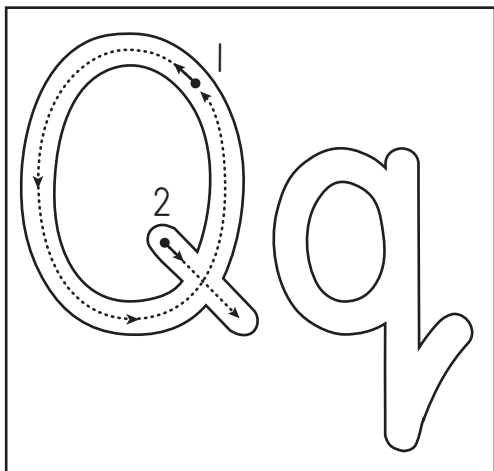

queen _ueen _ueen



quickly _uickly _uickly



quiet _uiet _uiet

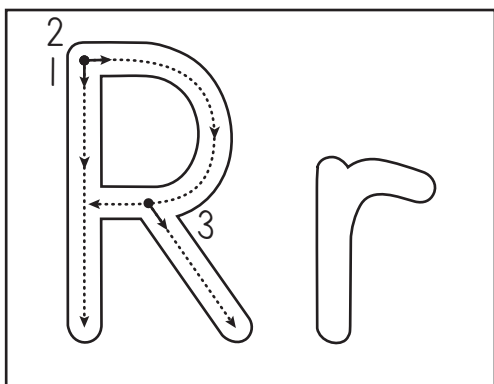

ruler _uler _uler



rabbit _abbit _abbit

Unit II Lesson 3

Say and write

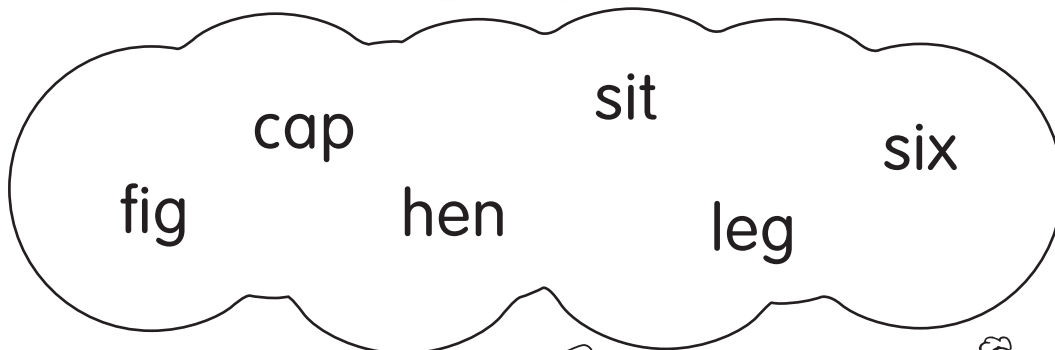

Match and join

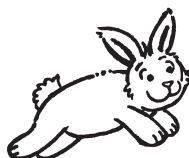

Qq

Rr



Unit 12 Lesson 1

Listen and match



1



2



3



4



Listen, trace and colour



1



2

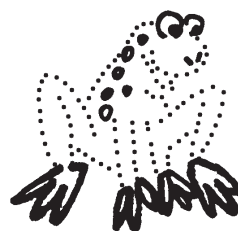

3

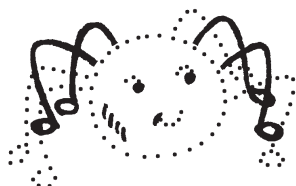

4

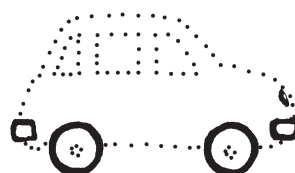

Unit 12 Lesson 2

Trace and write

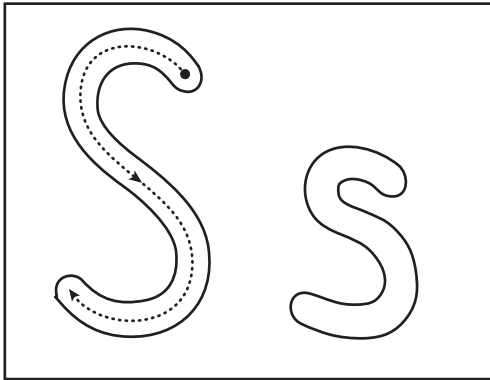

S S S

Ss Ss



spider _pider _pider



sock _ock _ock



Sam _am _am

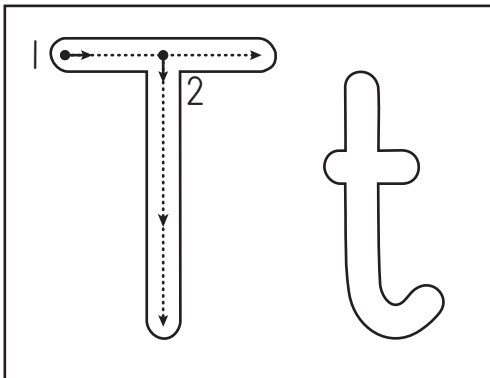

T T T

Tt Tt



top _op _op



tiger _iger _iger

Unit 12 Lesson 3

Listen and colour

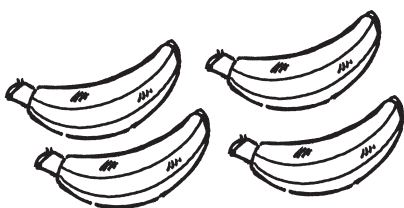
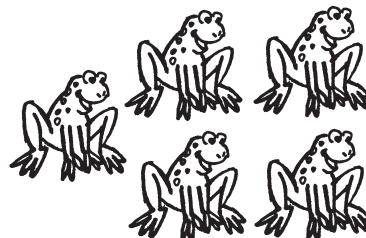
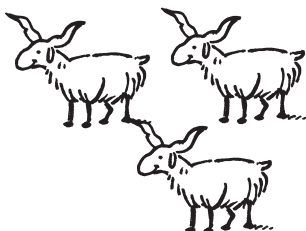
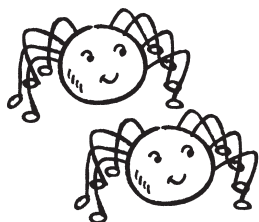

Match and write



hen six hat
jam fig leg



6



Revision 4

Listen and write

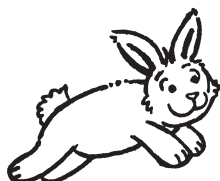

Revision 4

Listen and write

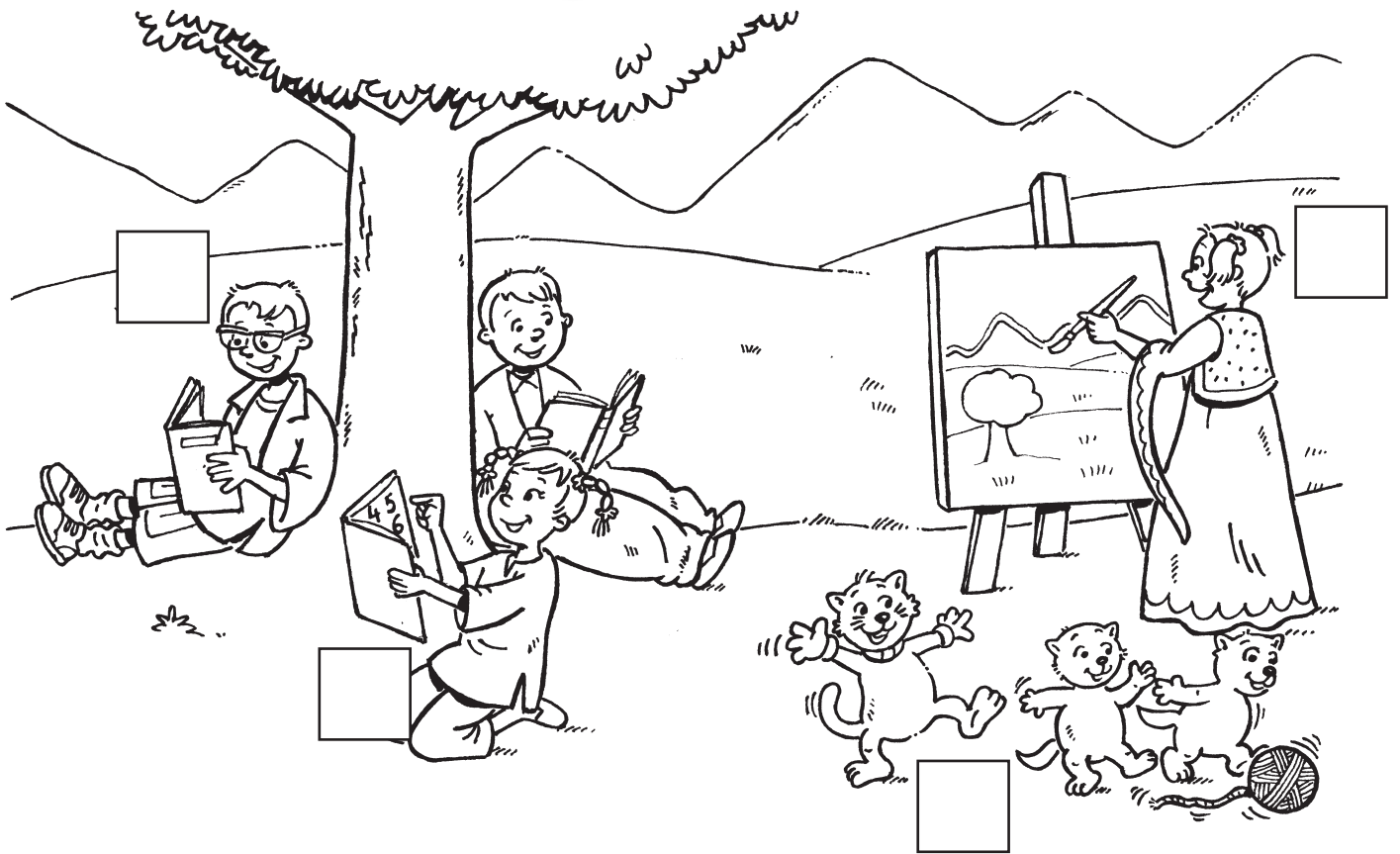

Find and write



1	2	3	4	5	6	7	8	9	10	11	12	13	14	15	16	17	18	19	20
a	b	c	d	e	f	g	h	i	j	k	l	m	n	o	p	q	r	s	t

2 1 7 = b a g

3 1 16 = _ _ _

8 5 14 = _ _ _

6 9 7 = _ _ _

19 9 20 = _ _ _

16 5 14 = _ _ _

12 5 7 = _ _ _

8 1 20 = _ _ _

Unit 13 Lesson 1

Listen and circle



1



2

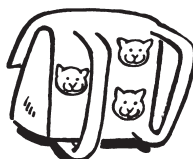
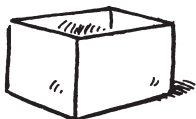

3

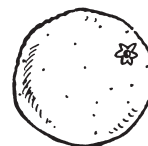

Listen and draw

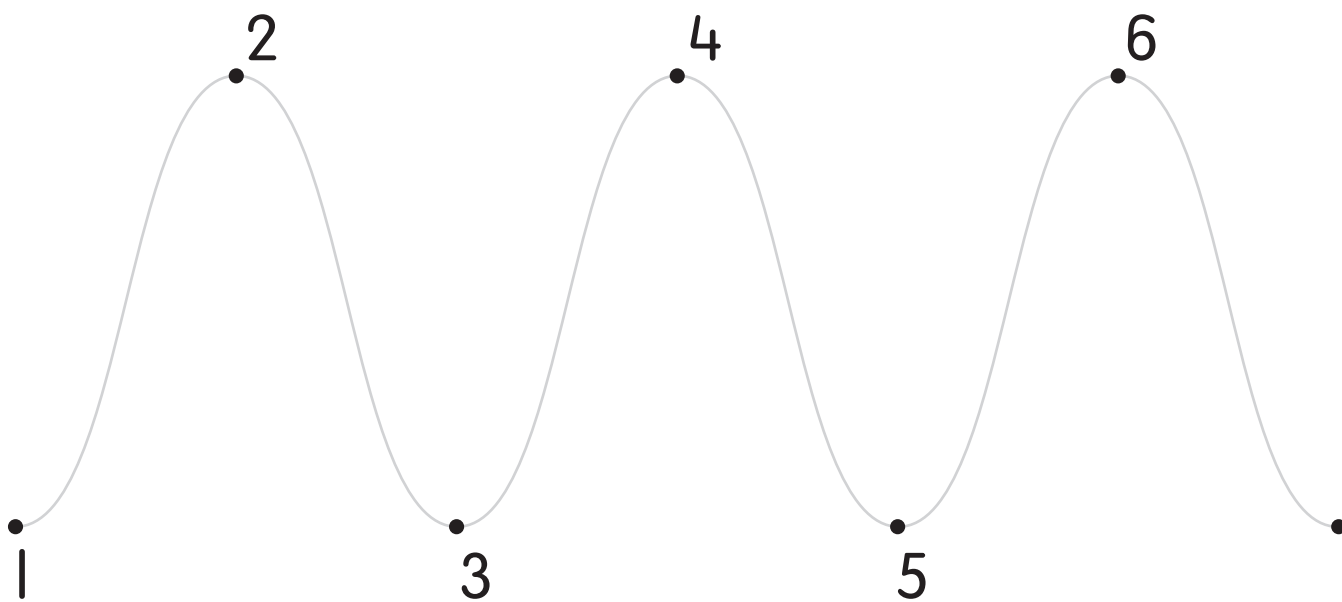

Unit 13 Lesson 2

Trace and write

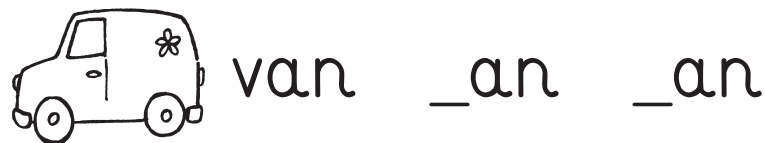
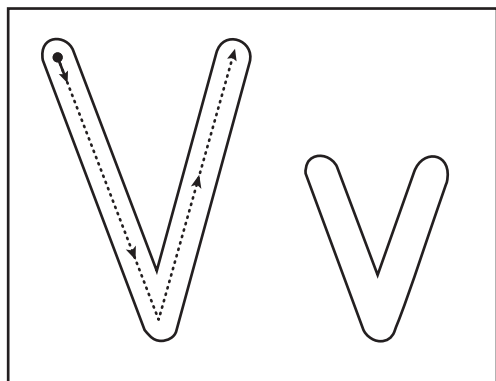
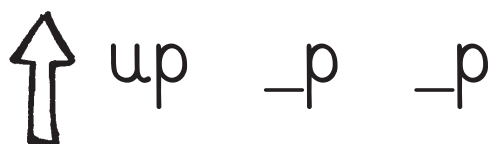
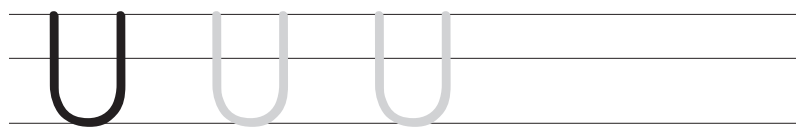
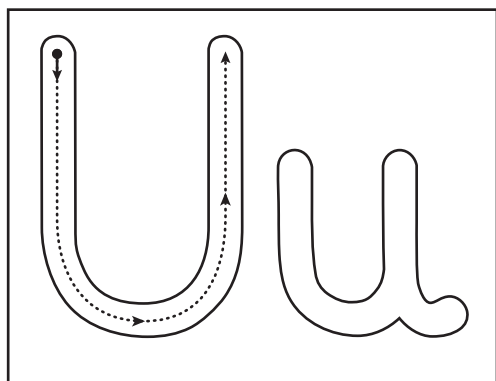

Join and match



d

x



t

o

p



b

g

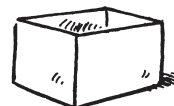

Unit 13 Lesson 3

Join and write



pot

dog

box

top

1 box

2

3

4

Unit 14 Lesson 1

Listen and number



123

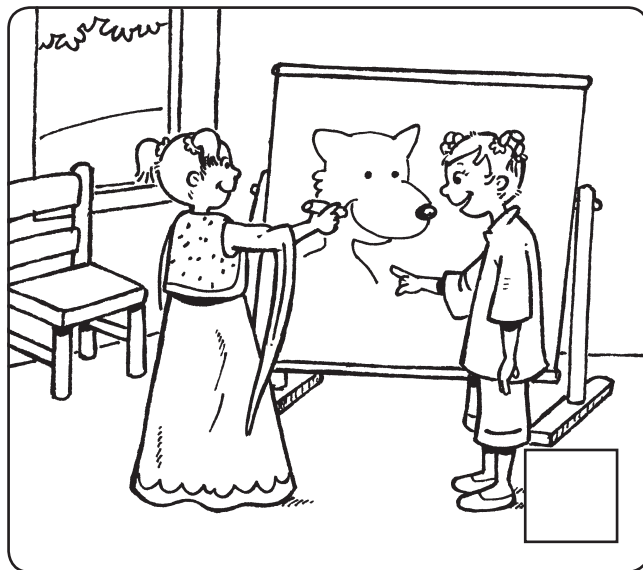
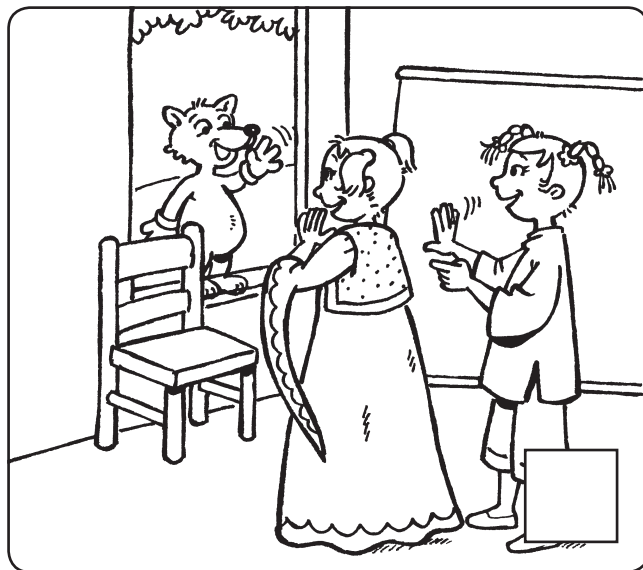
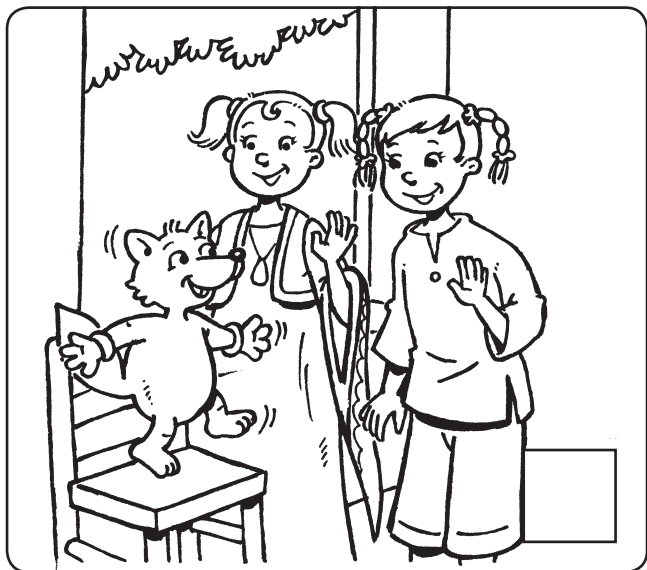

Listen and join

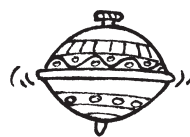
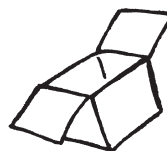

Unit 14 Lesson 2

Trace and write

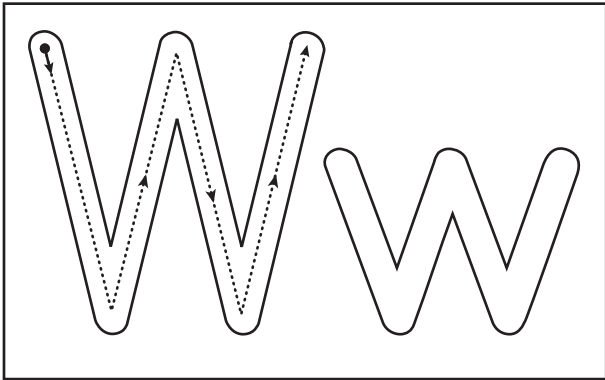

watch _atch _atch



window _indow _indow

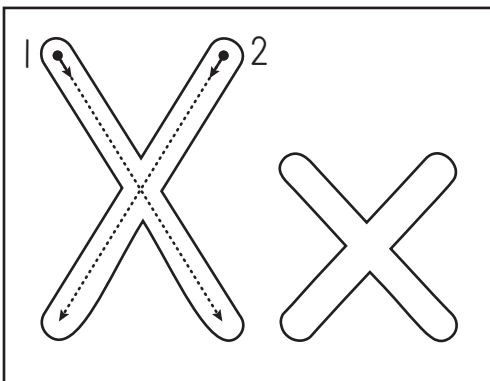

fox fo_ fo_



chair _air _air

ch ch ch

Unit 14 Lesson 3

Listen and draw

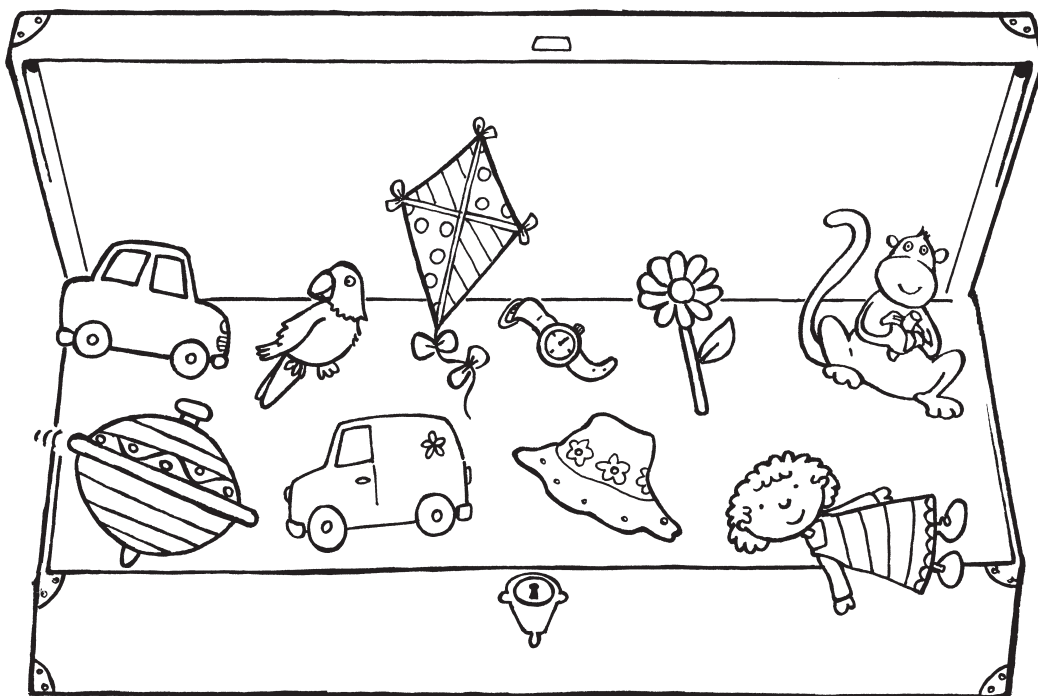















Find and write



Unit 15 Lesson 1

Listen and tick



1		<input type="checkbox"/>		<input type="checkbox"/>		<input type="checkbox"/>
2		<input type="checkbox"/>		<input type="checkbox"/>		<input type="checkbox"/>
3		<input type="checkbox"/>		<input type="checkbox"/>		<input type="checkbox"/>
4		<input type="checkbox"/>		<input type="checkbox"/>		<input type="checkbox"/>
5		<input type="checkbox"/>		<input type="checkbox"/>		<input type="checkbox"/>

Circle and say



y				
z				
v				
w				

Unit 15 Lesson 2

Trace and write

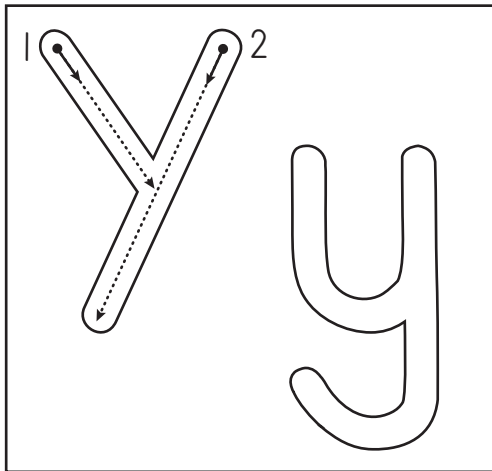

Y Y Y

y y y y

yo-yo _o-_o _o-_o



yogurt _ogurt _ogurt

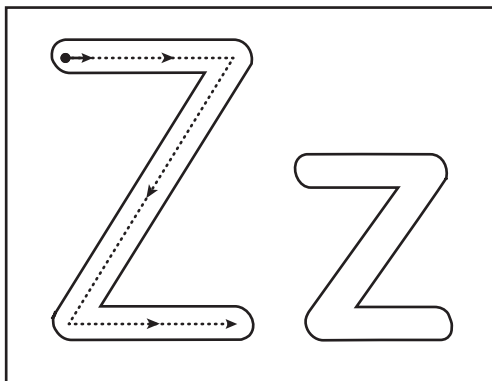

Z Z Z

Zz Zz



zip _ip _ip



zebra _ebra _ebra



shirt _irt _irt

sh sh sh

Unit 15 Lesson 3

Listen and colour



Revision 5

Listen and write



1 2 3













Circle and write



jug nut pot cap _____



cat fig hat top _____



ten leg six pen _____



fig jam jug six _____



pot cap top sit _____

Revision 5

Circle and write



Aa
_ veen



Tt
_ op



Mm
_ onkey



Ll
_ aura



Kk
_ itty



Ff
_ rog



Bb
_ anana



Cc
_ ar



Ss
_ am

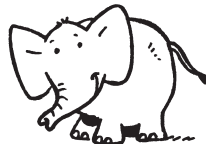

Ee
_ lephant

Find and colour



Aa Bb Cc Dd Ee Ff Gg Hh Ii
Jj Kk Ll Mm Nn Oo Pp Qq Rr
Ss Tt Uu Vv Ww Xx Yy Zz

Unit 16 Lesson 1

Join and say

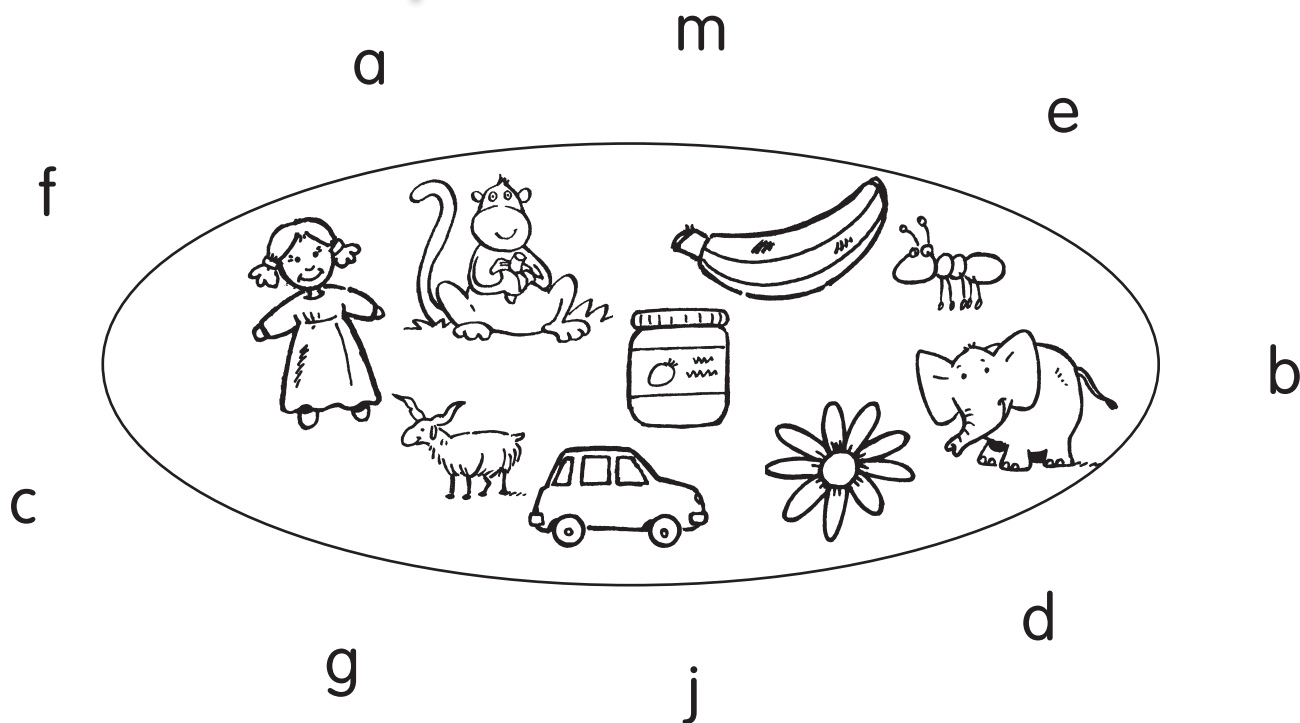

Listen and circle



Unit 16 Lesson 2

Trace, write and say



Aa Aa Aa



Bb Bb Bb



Cc Cc Cc



Dd Dd Dd



Ee Ee Ee



Ff Ff Ff



Gg Gg Gg



Hh Hh Hh



Ii Ii Ii



Jj Jj Jj



Kk Kk Kk



Ll Ll Ll



Mm Mm Mm

Unit 16 Lesson 3

Join and draw

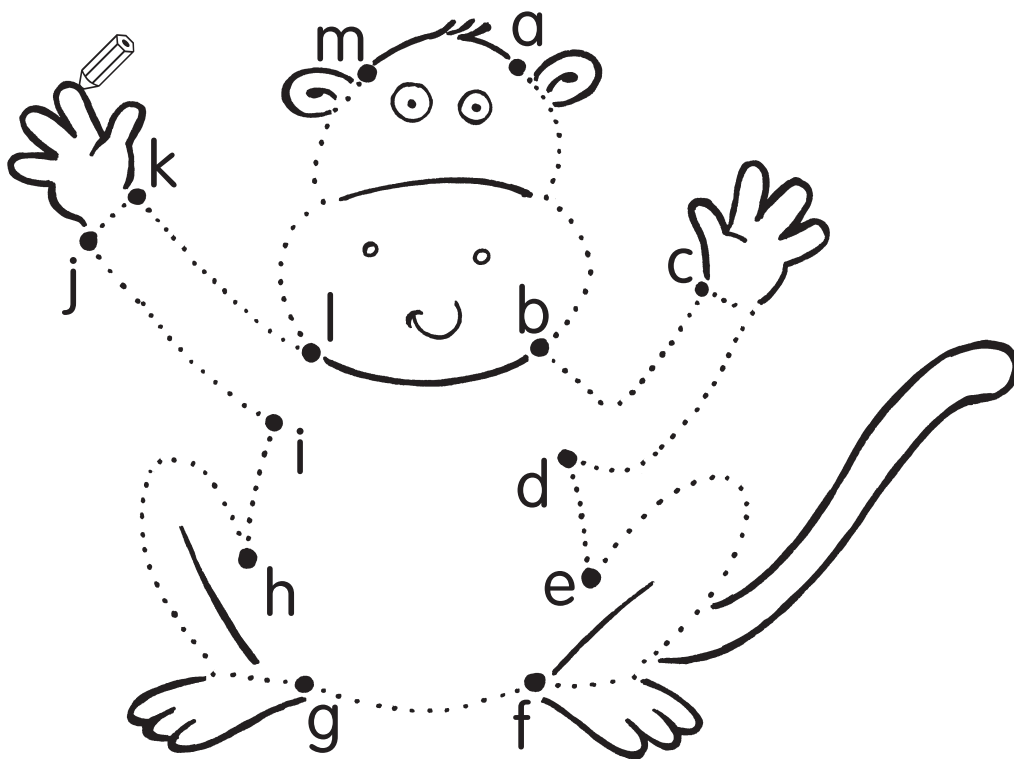

Listen and write



__ ug



__ ap



__ eg



__ ot



__ ix



__ at



__ og

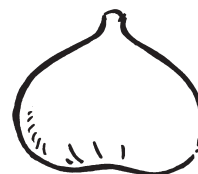

__ ig

Unit 17 Lesson 1

Listen, match and write

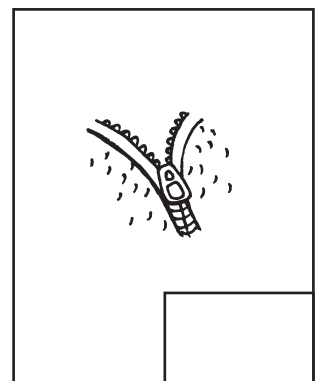
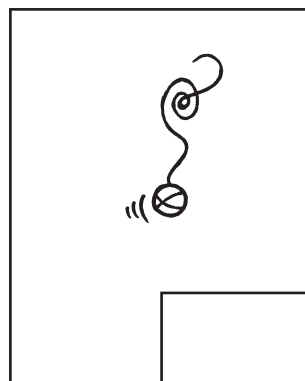
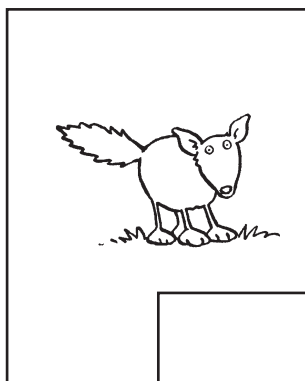
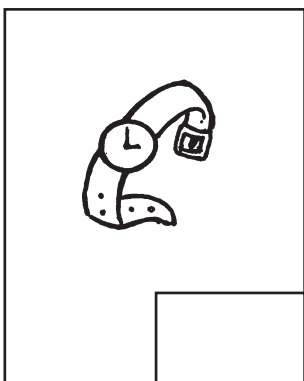
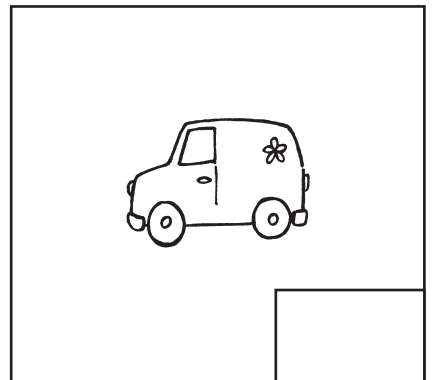
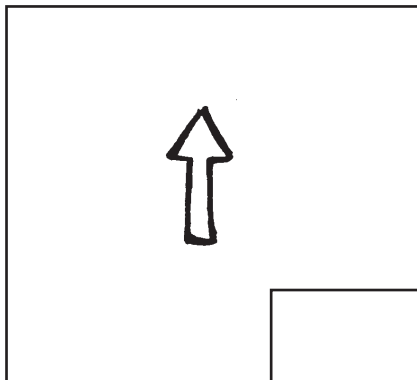
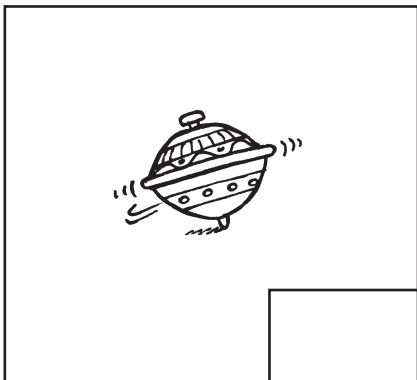
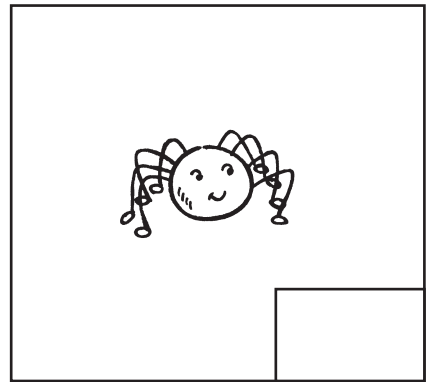
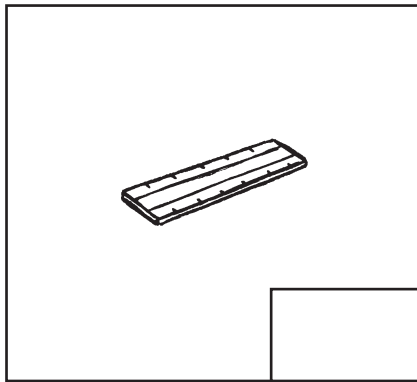
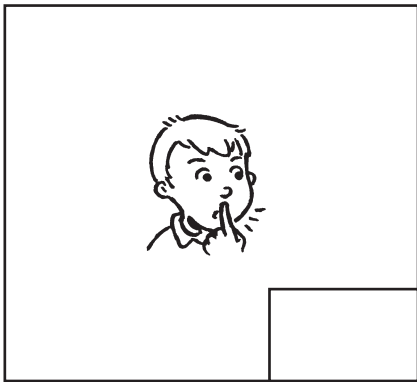
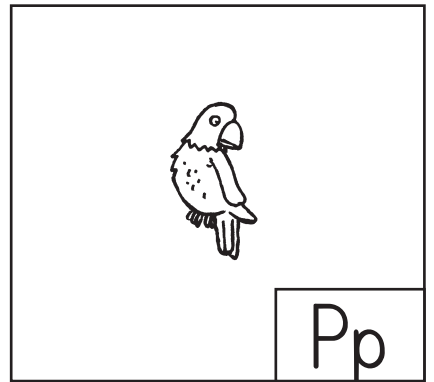
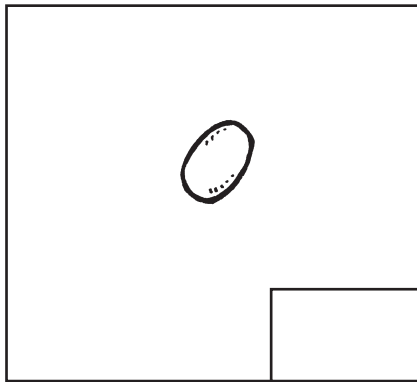
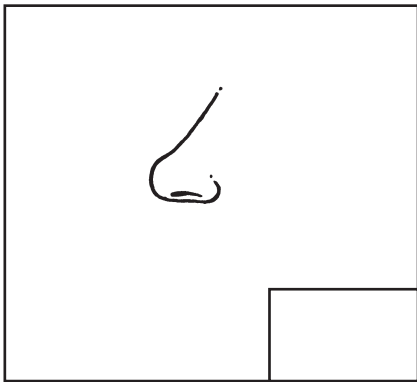

Unit 17 Lesson 2

Say, trace and write



Nn Nn Nn



Oo Oo Oo



Pp Pp Pp



Qq Qq Qq



Rr Rr Rr



Ss Ss Ss



Tt Tt Tt



Uu Uu Uu



Vv Vv Vv



Ww Ww Ww



Xx Xx Xx



Yy Yy Yy



Zz Zz Zz

Listen and write



1 _____ 2 _____ 3 _____ 4 _____ 5 _____ 6 _____

Unit 17 Lesson 3

Find and write

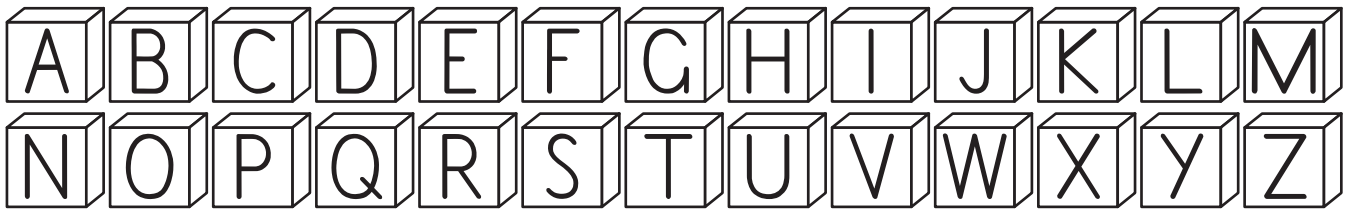
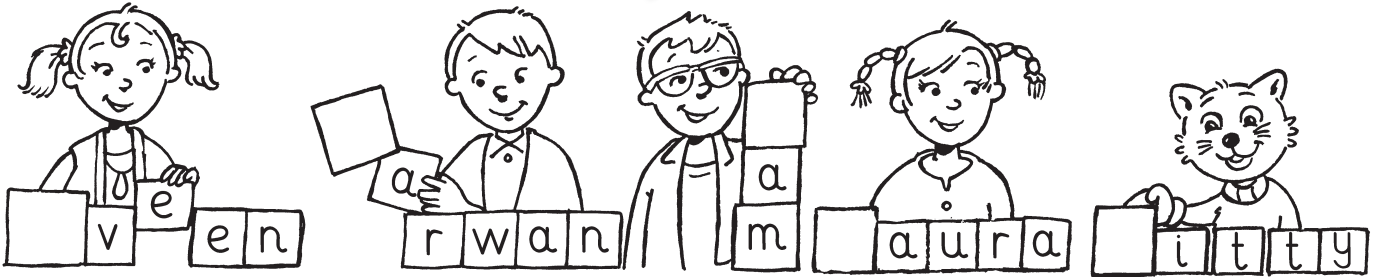

Write your name

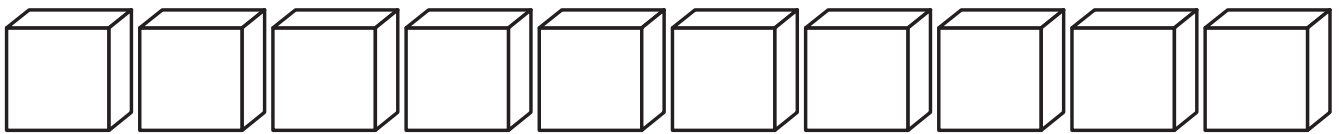

Find, write and read



tha tpo
tun xis nep

Unit 18 Lesson 1

Listen and write

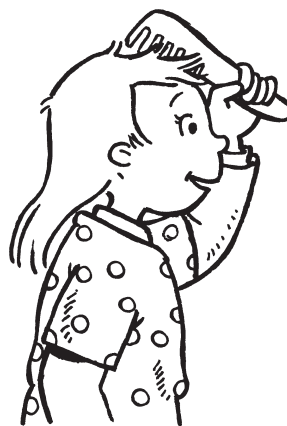

Unit 18 Lesson 2

Write 

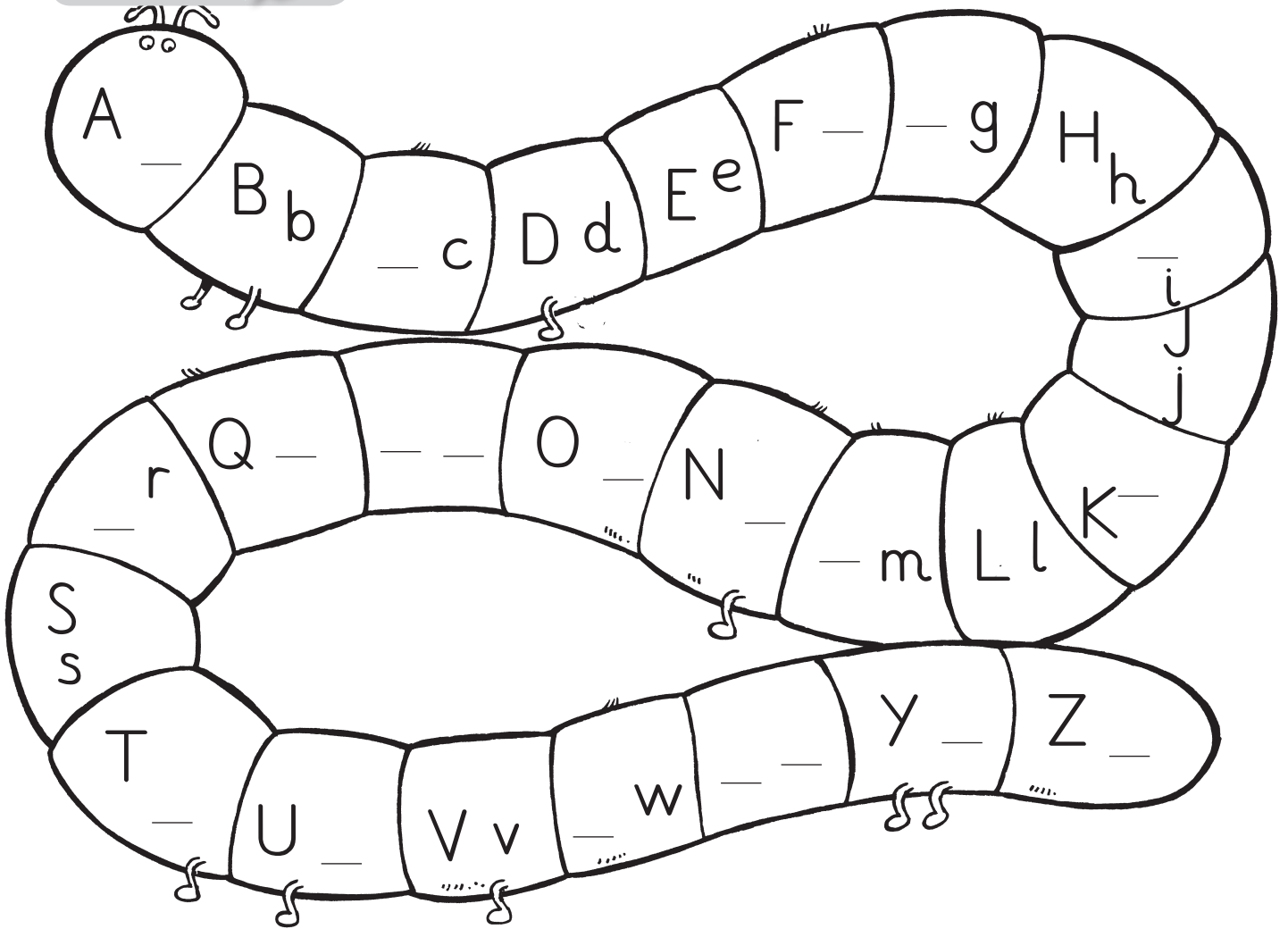

Join, write and read   

fig



cap

jug

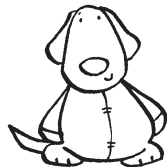
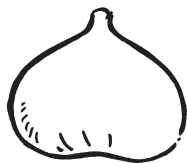

dog

leg

Unit 18 Lesson 3

Listen and trace

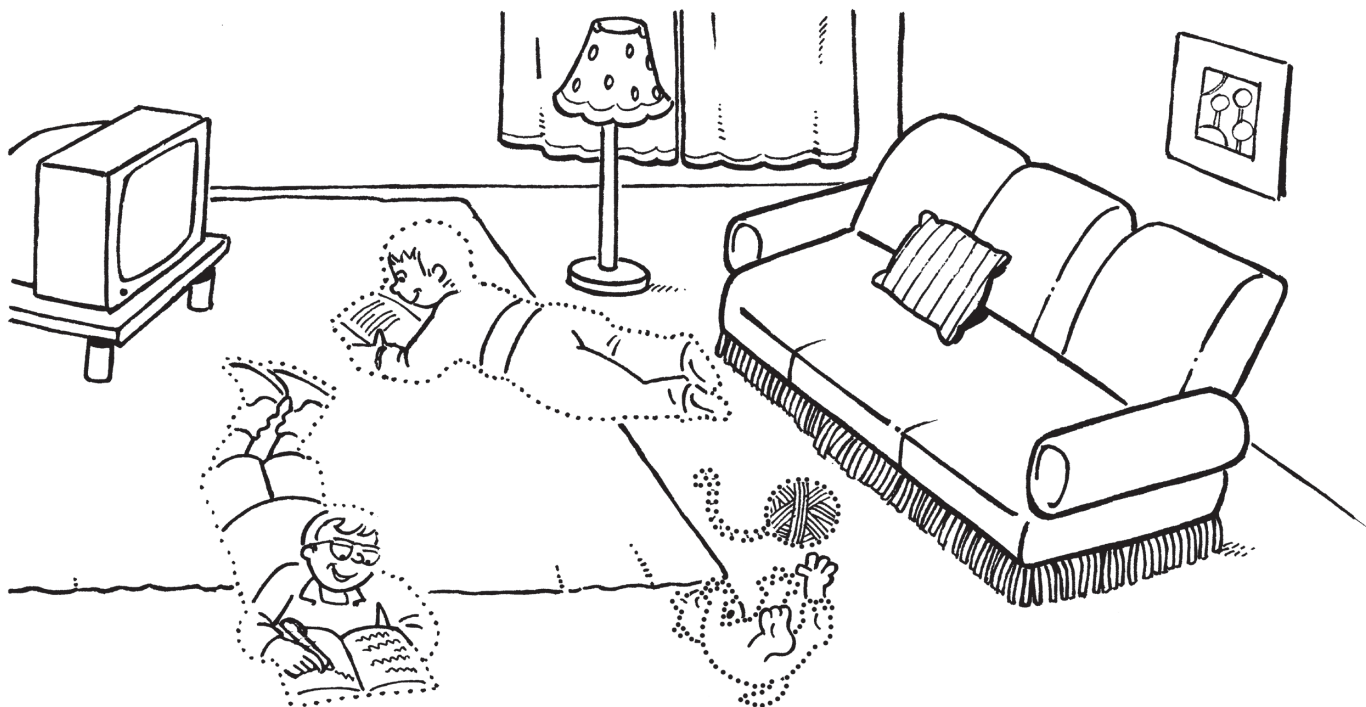

Revision 6

Listen, join and colour

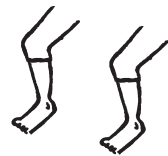
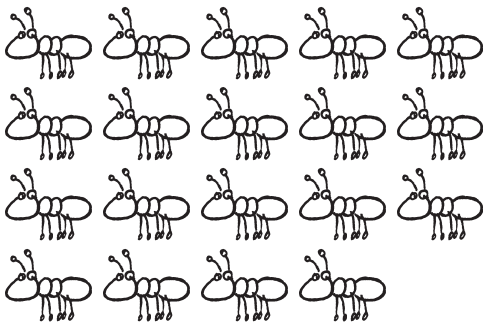
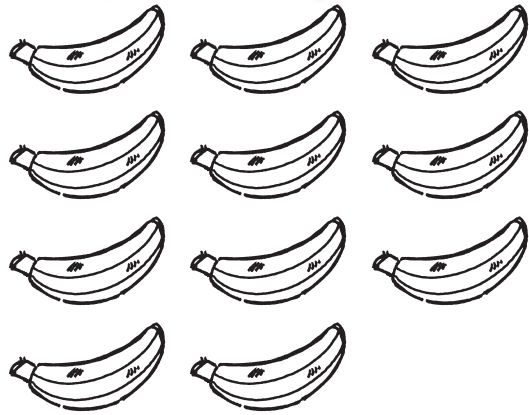

10 8 19
11 2 20

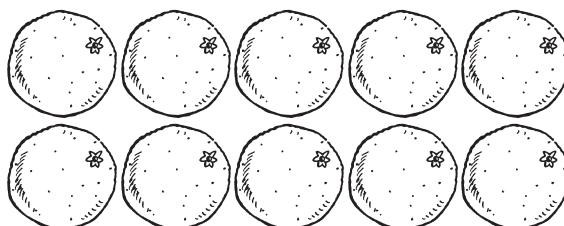
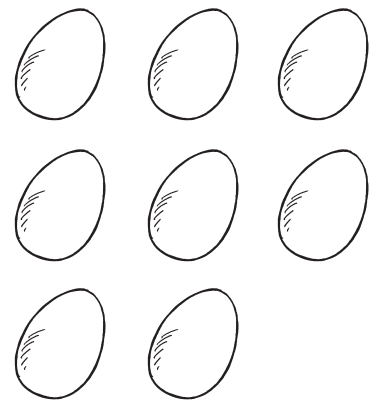
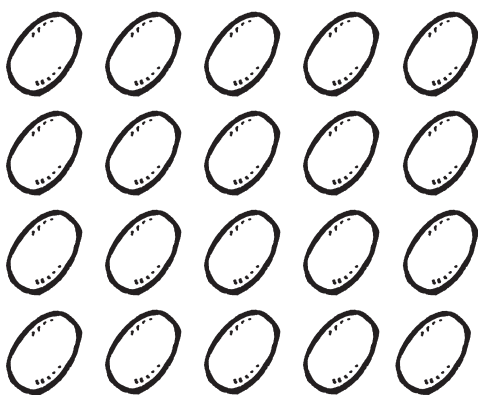

Revision 6

Write and read



jam



dog



six



leg



hat



nut

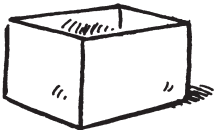

box



top



cat



jug



pot



cap



fig

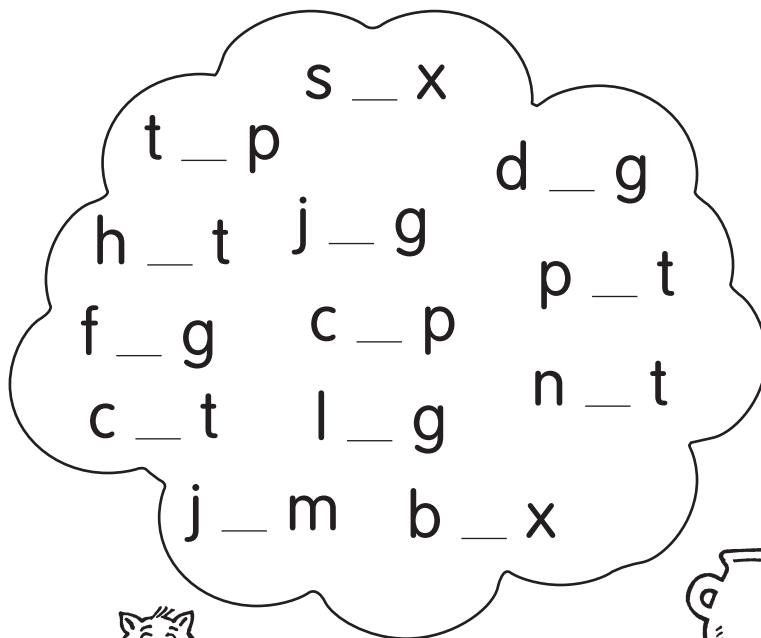

Listen and write









Revision 6

Find and write

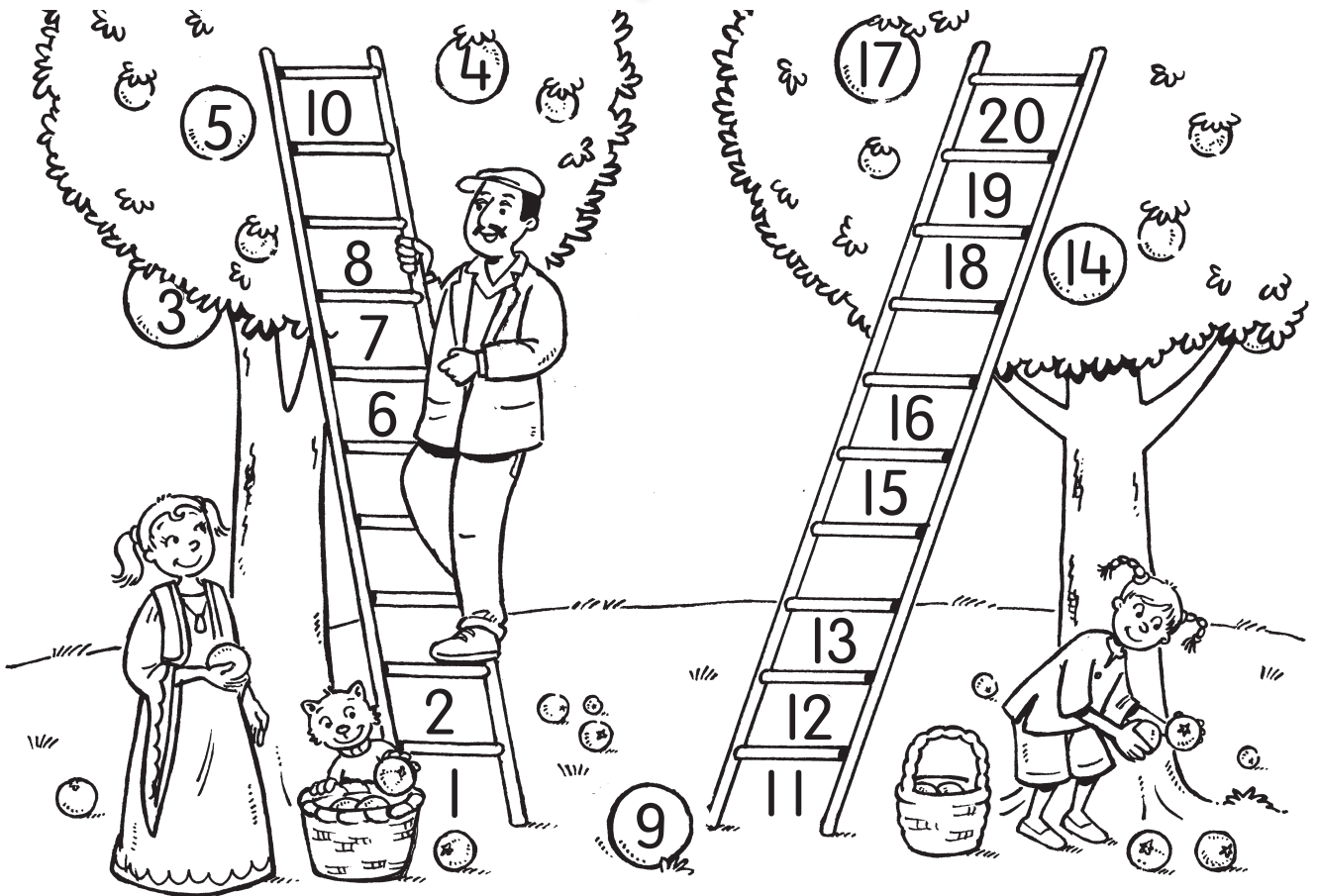

Find and circle



a	d	l	e	g
j	u	g	i	t
s	c	a	p	b
c	o	f	o	x
w	s	i	x	r

Revision 6

Match and write



Ss _____

Pp _____

Nn _____

Cc _____

Dd _____

Tt _____





Write and play



cat jam pen jug hen cap ten nut
fox dog six leg box fig bag

Listen and colour

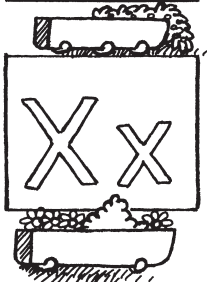
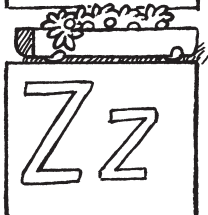

 Aa	Bb	Cc	Dd
Ee	Ff	Gg	Hh
Ii	Jj	 Kk	 Ll
Mm	Nn	Oo	Pp
Qq	Rr	 Ss	Tt
Uu	Vv	Ww	 Xx
Yy	 Zz		



Macmillan Education
Between Towns Road, Oxford OX4 3PP
A division of Macmillan Publishers Limited
Companies and representatives throughout the world

ISBN 978-1-4050-9712-3

Text © Hilary Thompson 2007
Design and illustration © Macmillan Publishers Limited 2007

First published 2007

All rights reserved; no part of this publication may be reproduced, stored in a retrieval system, transmitted in any form, or by any means, electronic, mechanical, photocopying, recording, or otherwise, without the prior written permission of the publishers.

Designed by Ken Vail Graphic Design, Cambridge
Illustrated by Chantal Kees
Cover design by Andrew Magee
Cover illustration by David Till

The publishers would like to thank the Primary English Committee and Nasreen Anwar Rasheed for their help and advice in developing this course.

Printed and bound in Egypt

2012 2011 2010 2009 2008
10 9 8 7 6 5 4 3 2